



**NIPOMO COMMUNITY
SERVICES DISTRICT
DANA RESERVE DEVELOPMENT
WATER AND WASTEWATER
SERVICE EVALUATION
FEBRUARY 7, 2022**

PREPARED FOR:

**NIPOMO COMMUNITY SERVICES DISTRICT
148 SOUTH WILSON STREET
NIPOMO, CA 93444**

PREPARED BY:



**530B PAULDING CIRCLE
ARROYO GRANDE, CA 93420
805 . 904 . 6530**



NIPOMO COMMUNITY SERVICES DISTRICT

DANA RESERVE DEVELOPMENT WATER AND WASTEWATER SERVICE EVALUATION

FEBRUARY 7, 2022

Report Prepared Under the Responsible Charge of:





Michael K. Nunley, PE C61801

Table of Contents

1.0	INTRODUCTION	1-1
1.1	Description of Proposed Project.....	1-1
1.2	Purpose of Study	1-1
1.3	Scope of Work	1-1
2.0	WATER SYSTEM	2-1
2.1	Water Supply and Demand	2-1
2.1.1.	Water Demand Projections	2-2
2.1.2.	Dana Reserve Water Demand Projections	2-4
2.2	Water System Facilities	2-8
2.2.1.	Existing Facilities.....	2-8
2.2.2.	Proposed Master Plan Facilities	2-9
2.3	Hydraulic Analysis Results and Recommendations	2-9
2.3.1.	Hydraulic Modeling Analysis	2-9
2.3.2.	Recommended Offsite Pipeline Improvements	2-16
2.3.3.	Evaluation of Proposed Onsite Pipeline Improvements.....	2-16
2.4	Storage Analysis and Recommendations	2-17
3.0	WASTEWATER COLLECTION SYSTEM	3-1
3.1	Wastewater Flows	3-1
3.1.1.	Flow Monitoring	3-1
3.1.2.	District Projections	3-4
3.1.3.	Dana Reserve Wastewater Flow Projections.....	3-10
3.2	Collection System Facilities	3-13
3.2.1.	Existing Facilities.....	3-13
3.2.2.	Proposed Master Plan Facilities	3-14
3.2.3.	Hydraulic Analysis Results and Recommendations	3-14
3.2.4.	Recommended Offsite Improvements	3-18
3.2.5.	Evaluation of Proposed Onsite Improvements	3-18
4.0	WASTEWATER TREATMENT FACILITY.....	4-1
4.1	Influent Flow and Loading Analysis	4-1
4.1.1.	District Projections	4-1
4.1.2.	Dana Reserve Projections and Impact on Flows and Loadings at Southland WWTF	4-2

4.2	Existing Facilities.....	4-3
4.3	Proposed Master Plan Facilities	4-3
4.4	Process Capacity Analysis	4-5
4.4.1.	Influent Lift Station.....	4-5
4.4.2.	Influent Screens.....	4-5
4.4.3.	Grit Removal.....	4-5
4.4.4.	Extended Aeration System	4-6
4.4.5.	Secondary Clarifiers.....	4-6
4.4.6.	Sludge Thickener	4-7
4.4.7.	Sludge Dewatering Screw Press and Sludge Drying Beds.....	4-7
4.5	Future Water Quality Requirements.....	4-8
4.6	Recommended Improvements.....	4-10
5.0	PROJECT COST OPINIONS	5-1
5.1	Offsite Water Improvements	5-1
5.2	Offsite Wastewater Collection and Treatment Improvements.....	5-1
6.0	CONCLUSIONS AND RECOMMENDATIONS	6-1
6.1	Water.....	6-1
6.2	Wastewater	6-1

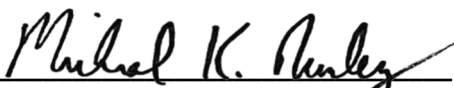
List of Tables

Table 2-1: Wholesale Water Agreement Delivery Schedule.....	2-1
Table 2-2: Total District Water Supply.....	2-2
Table 2-3 : Existing District Demands (2020).....	2-2
Table 2-4: NCS D Potential Future System Demands (Maximum Anticipated Infill Development).....	2-4
Table 2-5: Developer Provided Water Use Factor and Demand Projections (Table 5.1 from DRSP Update).....	2-5
Table 2-6: Dana Reserve Water Demand Factor Comparison.....	2-6
Table 2-7: NCS D Dana Reserve Water Demand Comparison.....	2-6
Table 2-8: Water Supply Allocation and Demand.....	2-7
Table 2-9: Existing Water Pipeline Statistics.....	2-8
Table 2-10: Hydraulic Analysis Scenarios 1-9.....	2-11
Table 2-11: Hydraulic Analysis Scenarios 10-23.....	2-14
Table 2-12: NCS D Served Population Summary.....	2-17
Table 2-13: Water System Storage Capacity.....	2-18
Table 3-1: Summary of Flow Monitoring Results (Oct. 23 – Nov. 28, 2020).....	3-1
Table 3-2: Historical Southland WWTF Influent Flow and Loading (January 2019 – December 2020).....	3-2
Table 3-3: Sewer Flow Return Factors by Land Use.....	3-4
Table 3-4: Estimated Total Existing Sewer Flows.....	3-5
Table 3-5: Projected Future Sewer Flows (Not including Existing).....	3-6
Table 3-6: Estimated Sewer Flow for FM01 Basin.....	3-7
Table 3-7: Estimated Sewer Flow for FM02.....	3-7
Table 3-8: Estimated Sewer Flow for FM03.....	3-8
Table 3-9: Projected Future Sewer Flows (Not including Existing).....	3-9
Table 3-10: Historical Southland WWTF Influent Flow.....	3-10
Table 3-11: Developer Provided Wastewater Generation Factor and Demand Projections (Table 5.2 from DRSP Update).....	3-11
Table 3-12: Dana Reserve Wastewater Flow Projections using Water Production-Based and 2007 Sewer Master Plan-Based Methods.....	3-12
Table 3-13: NCS D Dana Reserve Wastewater Flow Comparison.....	3-13
Table 3-14: Existing and Future Flows.....	3-13
Table 3-15: Existing Sewer Pipeline Statistics.....	3-14
Table 3-16: Dana Reserve Sewer Model Results.....	3-16
Table 4-1: Existing and Projected Influent Flows and Loadings from District Service Area.....	4-1
Table 4-2: Projected Influent Flows and Loadings from Dana Reserve Project.....	4-2
Table 4-3: Projected Influent Flows and Loadings from Dana Reserve Project and District Service Area.....	4-2
Table 4-4: Southland WWTF Phasing Plan.....	4-3
Table 4-5: Influent Lift Station Capacity (One Pump Operating).....	4-5
Table 4-6: Influent Lift Station Capacity (Two Pump Operating).....	4-5
Table 4-7: Extended Aeration Basin Capacity (One Basin).....	4-6
Table 4-8: Secondary Clarifier Existing Capacity.....	4-7
Table 4-9: General Order R3-2020-0020 Secondary Treatment Effluent Limits (Tables 5 and 6 of the Order).....	4-9
Table 4-10: Extended Aeration Basin Capacity for Denitrification via Wave Oxidation (Two Basins).....	4-9
Table 4-11: Extended Aeration Basin Capacity for Denitrification via Wave Oxidation (Three Basins).....	4-10
Table 4-12: Summary of Southland WWTF Evaluation.....	4-10
Table 5-1: Water Transmission Main to Serve Dana Reserve.....	5-1
Table 5-2: Water System Storage and Looping Improvements to Serve Dana Reserve.....	5-1
Table 5-3: Wastewater Improvements to Serve Existing Conditions and Dana Reserve.....	5-1
Table 6-1: Recommendations for NCS D Water System Improvements.....	6-1

List of Figures

Figure 2-1: Proposed Pipeline Improvements to the District Water System 2-13

Figure 3-1: Wastewater Flow Meter Locations 3-3

Figure 3-2: Sewer Collection System Improvements 3-17

Figure 4-1: Southland WWTF 4-4

Figure 6-1: Proposed Water Distribution System Improvements 6-3

Figure 6-2: Proposed Joshua Road Pump Station Reservoir Improvements 6-4

Figure 6-3: Wastewater Collection System Improvements 6-5

Figure 6-4: Proposed Southland WWTF Improvements 6-6

List of Appendices

- Appendix A: Sewer Flow Monitoring 2020 Nipomo, CA
- Appendix B: Process Flow Diagram
- Appendix C: Opinions of Probable Cost

1.0 INTRODUCTION

1.1 Description of Proposed Project

The Dana Reserve Development (Project) is a proposed multiuse neighborhood encompassing 288 acres of currently undeveloped land. The property is not within the Nipomo Community Services District (District) service area but is within the District's Sphere of Influence (SOI). The development includes a variety of single-family residences, condominiums, townhomes, and multifamily apartments. The development also incorporates open spaces and public parks, as well as various commercial uses including a village center, flex commercial/light industrial, neighborhood barn, hotel, daycare center, and a community college campus.

The developer has applied for annexation to the Nipomo Community Services District for water and wastewater services.

1.2 Purpose of Study

This study evaluated the impact this proposed development will have on District water and wastewater facilities. Recommended improvements from the Water and Sewer Master Plan Update (Cannon, 2007) and Southland WWTF Facility Master Plan Amendment 1 (AECOM, 2010) were reviewed to identify the improvements required to provide service to the project.

1.3 Scope of Work

The Scope of Work for the project included the following tasks:

Evaluation of Water Supply, Storage, and Distribution Facilities (Offsite and Onsite)

- Review Water Supply Assessment provided by developer and compare to District projections.
- Update existing water distribution system model with current demands from billing data and future demand from proposed annexation area.
- Review Water Master Plan, confirm status of master-planned projects, and update model with completed projects that may be necessary to support the development.
- Identify Master Planned projects which should be implemented to support the development.
- Perform model runs to identify offsite improvements necessary to support development. An evaluation of fire flow requirements, typical operating pressure ranges, and ability of the system to deliver Supplemental Water were performed. System storage requirements were also identified.
- Provide master-planning level cost opinion for proposed improvements, using unit costs escalated from previous master plans or planning documents.
- Evaluate onsite improvements recommended for development to confirm pipe sizes and pressure ranges are adequate for fire protection, maximum day, and peak hour demands.

Evaluation of Wastewater Collection Facilities (Offsite and Onsite)

- Place flowmeters at three (3) locations in the District sewer system for up to 30 days (to be performed by MKN's subconsultant, ADS).
- Review wastewater flow projections provided by developer and compare to District projections.
- Update existing collection system model with current flows from water billing data and future flows from proposed annexation area.
- Review Sewer Master Plan, confirm status of master-planned projects, and update model with completed projects that may be necessary to support the development.
- Identify Master Planned projects which should be implemented to support the development.
- Perform model runs to identify offsite improvements necessary to support development.
- Provide master-planning level cost opinion for proposed improvements, using unit costs escalated from previous master plans or planning documents.

Wastewater Treatment Capacity Evaluation

- Develop design flow and loading for the Southland Wastewater Treatment Facility under existing conditions. This analysis will include a review of past flow and loading records since the Phase I facility was completed; review of flow and loading projections from the Southland Wastewater Treatment Facility Master Plan (WWTF Master Plan); and a review of the flow and loading projections from the annexation area. The total flow and loading with contribution from the annexation area will be tabulated and compared to flows anticipated in the WWTF Master Plan.
- Discuss the ability of each unit process to meet existing flows and loads including the annexation area will be discussed for each phase. A process model will not be developed but flows and loads will be compared to typical loading rates for similar facilities based on industry standards and vendor-supplied information. Provide a recommendation as to whether future phases of the WWTF Master Plan should be implemented to address increased flows and loading.
- Provide master-planning level cost opinion for proposed improvements, using unit costs escalated from the previous WWTF Master Plan or other planning documents.

2.0 WATER SYSTEM

2.1 Water Supply and Demand

Water Supply

Historically, the District has relied heavily on pumped groundwater from the Nipomo Mesa Management Area (NMMA), a subbasin within the Santa Maria Groundwater Basin. The NMMA Technical Group, which is the court-assigned entity responsible for managing groundwater within the NMMA, has declared a Stage IV water severity condition for the subbasin. This condition requires purveyors reduce groundwater deliveries to 50% of the average production recorded between years 2009 and 2013. This results in a voluntary groundwater reduction goal of 1,267 AFY of pumped groundwater for the District.

Groundwater was the sole source of the District’s water supply until 2015, when the District began importing water from the City of Santa Maria (City) as part of the Nipomo Supplemental Water Project (NSWP), dictated by the Final Judgment. The District executed the Wholesale Water Supply Agreement (Wholesale Agreement) with the City on May 7, 2013. Supplemental Water consists of a “municipal mix” of both surface water from the State Water Project and groundwater from the City of Santa Maria. The Wholesale Agreement requires a minimum water delivery to the District of 2,500 AFY by the 2025-26 fiscal year, a readily available amount of 500 AFY, and a maximum allowable delivery of 6,200 AFY. Due to a current license agreement limitation, this report focuses on the minimum delivery of 2,500 and the readily available 500 AFY totaling 3,000 AFY.

In addition to the Wholesale Agreement, a Water Replenishment Agreement requires water delivery to Woodlands Mutual Water Company (WMWC), Golden State Water Company (GSWC), and Golden State Water Company Cypress Ridge (GSWCCR). Table 2-1 outlines the required Wholesale Agreement water delivery schedule.

Table 2-1: Wholesale Water Agreement Delivery Schedule	
AFY	Effective Delivery Date
1,000	7/1/2020
2,500	7/1/2025
3,000	Planning Capacity
6,200	Maximum Capacity

While the District is obligated to meet the minimum delivery schedule from the Wholesale Agreement, the District still has to maintain and operate groundwater wells to meet additional demands that the NSWP cannot meet, and to comply with State regulations. **Table 2-1** outlines the required Wholesale Agreement water delivery schedule.

Table 2-2 depicts the total supply available to the District including delivered water from the NSWP based on the above delivery schedule and maximum groundwater allocation as required by the Final Judgment.

Table 2-2: Total District Water Supply	
Source	Water Supply
	AFY
NCS D Groundwater Available ¹	1,267
NSWP Allocation	2,500
Total Future Water Supply	3,767
NSWP New Development Allocation ²	500
Maximum Future Water Supply³	4,267
Notes:	
<ol style="list-style-type: none"> 1. NCS D’s current voluntary groundwater reduction goal based on fifty percent reduction from average production in the FY’s 2009-10 through 2013-14 as required by the Final Judgment, or fifty percent of 2,533 AFY based on Stage 4. 2. While this additional allocation is available to the District for delivery under the Wholesale Agreement, it should only be taken as needed. After the District requests 3,001 AFY, the District must maintain that delivery. It is believed the District may not have enough demand to warrant additional water delivery past 2,500 AFY in the planning horizon contemplated in this report. 3. Table 7-4, NMMA Stage 4, 2020 UWMP. 	

2.1.1. Water Demand Projections

Existing water demands for the District are summarized in **Table 2-3** based on calendar year 2020 usage as reported in the annual water usage report submitted to DWR and the 2020 UWMP update.

Table 2-3 : Existing District Demands (2020)		
Use Type	2020 Actual	
	Level of Treatment When Delivered	Volume (AF)
Single Family	Drinking Water	1,326
Multi-Family	Drinking Water	122
Commercial	Drinking Water	76
Landscape	Drinking Water	271
Other	Drinking Water	4
Agricultural Irrigation	Drinking Water	12
Losses	Drinking Water	237
	TOTAL (AF)	2,048
Notes:		
<ol style="list-style-type: none"> 1. Demands = Annual water consumption by customer type as shown above. 2. Values represent use as reported to DWR for 2020. 		

Projections under future conditions were developed in the 2020 UWMP and are summarized in **Table 2-4**. Future demand conditions included water service to parcels within the existing service area that are not currently served. This included parcels with Reserved District Capacity allocation (parcels not currently on the District’s system but have potential to be added to the system), parcels served by private wells, vacant parcels, and ADUs associated with that growth. Criteria used in this analysis for subdivision and/or adding an ADU are listed below:

1. District's GIS parcel mapping data was used to identify existing land use designation and acreage information.
2. Existing and vacant residential single family (RSF) parcels greater than 12,000 square foot (sf) and served by a community sewer are allowed by ordinance to subdivide into 6,000 sf lots.
3. Existing and vacant residential single family (RSF) parcels on septic have a 1.0-acre minimum lot size requirement.
4. Existing and vacant residential suburban (RS) parcels greater than 2.0 acres are allowed by ordinance to subdivide to 1.0 acre lots.
5. Existing and vacant residential rural (RR) parcels greater than 10.0 acres are allowed by ordinance to subdivide to 5.0 acre lots.
6. Blacklake Village residential parcels have ADU capability (based on Proposed Amendments to Title 22).
7. Residential Multi-Family (RMF) parcels do not have ADU capability, regardless of parcel size.
8. Land uses that allow ADU dwellings include the following:
 - a. Commercial, Retail (CR)
 - b. Office and Professional (OP)
 - c. Recreation (REC)
 - d. Residential, Rural (RR)
 - e. Residential, Suburban (RS)
 - f. Residential, Single Family (RSF)

This "Maximum Anticipated Infill Development" scenario assumes that every parcel that has the capability to subdivide based on the above criteria will subdivide. This does not affect the potential future demand for existing customers because neither the total area of the parcel nor the usage factor changes. This increase in subdivision does increase the total number of parcels available to add an ADU. It is assumed every new parcel able to add an ADU will do so. Total ADU demand is projected by multiplying all eligible parcels by a demand factor of 0.11 AFY/ADU. The "Maximum Anticipated Infill Development" scenario is a conservative approach, but is appropriate to assess future worst case scenario needs since the District does not control land use or zoning within its service area.

This scenario also includes current District water demand, as well as the required deliveries to the Woodlands Mutual Water Company (WMWC), Golden State Water Company (GSWC), and Golden State Water Company Cypress Ridge (GSWCCR) according to the Water Replenishment Agreement, and shown in **Table 2-4** below.

Table 2-4: NCS D Potential Future System Demands (Maximum Anticipated Infill Development)	
Description	Water Demand
	AFY
Current NCS D Customer Usage	
Existing District Customers ¹	2,048
Potential District Maximum Anticipated Infill	
Future Demand	340
Future Demand Subtotal²	2,388
District Interconnections	
WMWC	417
GSWC	208
GSWCCR	208
Interconnection Subtotal	833
Total Future Demand with Interconnections (AFY)²	3,221
Notes:	
1. Table 4-1, 2020 UWMP.	
2. Table 4-3, 2020 UWMP. Total District projected water demand for year 2045, excluding anticipated demand from the proposed Dana Reserve development.	

2.1.2. Dana Reserve Water Demand Projections

The proposed Dana Reserve development includes approximately 1,235 residential units, 18.9 acres of commercial land use, and 31.5 acres of public parks and streetscapes. Applying usage factors derived from the 2016 NCS D Urban Water Management Plan (UWMP) and additional factors pulled from the City of Santa Barbara and the County of SLO, the Developer estimated a total water demand for the new development of 370 acre-ft/year (AFY). This estimate includes a 10% contingency to account for additional miscellaneous water use. **Table 2-5** shows the developer’s water use factors used and total demand projections for the Dana Reserve development as outlined in the most recent Water Supply Assessment update by RRM Design Group (2020) as cited below.

Table 2-5: Developer Provided Water Use Factor and Demand Projections (Table 5.1 from DRSP Update)				
Land Use Category	Number of Units or Acres	Water Use Factor³ (AFY)	Potable Water Demand (AFY)	Daily Demand² (gpd)
Residential				
Condos	173 units	0.13 AFY/unit	22.14	-
Townhomes	210 units	0.14 AFY/unit	30.24	-
Cluster	124 units	0.21 AFY/unit	25.79	-
4,000-5,999 SF	463 units	0.21 AFY/unit	96.30	-
6,000-7,000+ SF	225 units	0.34 AFY/unit	75.61	-
Affordable	75 units	0.14 AFY/unit	10.84	-
<i>Subtotal</i>			<i>261.13</i>	<i>232,900</i>
Commercial¹				
Village Commercial	4.4 ac	0.17 AFY/1,000 sf	8.69	-
Flex Commercial	14.5 ac	0.17 AFY/1,000 sf	28.63	-
<i>Subtotal</i>			<i>37.32</i>	<i>33,319</i>
Landscape				
Village and Commercial Area ⁴	6.3 ac	1.0 AFY/ac	6.30	-
Public Recreation	10.0 ac	1.0 AFY/ac	10.00	-
Neighborhood Parks	15.0 ac	1.0 AFY/ac	15.00	-
Streetscape/Parkways	6.5 ac	1.0 AFY/ac	6.50	-
<i>Subtotal</i>			<i>37.80</i>	<i>28,121</i>
<i>Project Total</i>			<i>336.25 AFY</i>	<i>300,185 gpd</i>
<i>Project Total (with 10% contingency)</i>			<i>369.88 AFY</i>	<i>330,207 gpd</i>
Notes:				
1. Assumes 0.15 gpd/sf and 33% useable site area for buildings.				
2. Conversion factor: 1 AFY equals 892.742 gpd.				
3. Water usage factors used by the developer in the table above are derived from the following sources: 2016 NCSU UWMP, the City of Santa Barbara and the County of San Luis Obispo.				
4. Assumed 33% of the total commercial acreage is available for landscape.				
5. Updated Table 5.1 provided in email dated September 23, 2020, from Robert Camacho, RRM Design Group				

The water demand factors provided by the developer were compared to the standard water demand factors from the 2007 Water Master Plan referenced in the District Water and Wastewater Standards as well as calculated demand factors based on the 5-year and 10-year District average annual water production. This comparison is shown below in **Table 2-6**. The land use categories used by the developer (RRM) do not line up with categories that the District has outlined in the 2007 Water Master Plan (WMP) or within the District’s current water model. As such, the District land use factors were applied to the most appropriate Dana Reserve land use category.

Table 2-6: Dana Reserve Water Demand Factor Comparison

Land Use Category	Dana Reserve Water Supply Assessment ¹ (AFY/acre)	2007 Water Master Plan (AFY/acre)	5-Year Production Average (2016-2020 – AFY/acre)	10-Year Production Average (2011-2020 – AFY/acre)
Condominiums	2.29	3.75	2.22	2.47
Townhomes	2.60	3.75	2.22	2.47
Small Lots SFR ²	1.27	2.10	1.26	1.40
Medium Lot SFR	1.42	2.10	1.26	1.40
Affordable	2.71	3.75	2.22	2.47
Commercial	1.96	1.42	1.33	1.49
Parks/Streetscapes	1.00	0.98	0.71	0.79

Notes:

1. Developer originally used residential demand factors in the form of GPD/unit to calculate anticipated demand for residential development. Using information provided in the Dana Reserve Water Supply Assessment describing total areas for each land use category, average demand factors in the form of AFY/acre were calculated by MKN.
2. Small Lot SFR (Single Family Residence) includes “Cluster” Land Use Category shown in **Table 2-2**.

These demand factors were used to calculate average day demand, maximum day demand (MDD), and peak hour demand (PHD) for the Dana Reserve development. MDD and PHD were calculated by multiplying the average day demand by peaking factors of 1.7 and 3.78 (according to current District Standard Specifications) respectively. Each of the District projections include a 10% contingency to account for miscellaneous demand and total demands are outlined below in **Table 2-7**. We recommend using the projection calculated based on the 10-year production average, because it represents a range of years including both drought and non-drought conditions. While this is a conservative approach, it is an appropriate baseline for planning to meet future water demands. This is also the approach applied to potential annexations in the 2020 UWMP.

Table 2-7: NCS D Dana Reserve Water Demand Comparison

Projection Method	Average Day Flow ¹ (AFY)	Average Day Flow (MGD)	Maximum Day Flow (MGD)	Peak Hour Flow (MGD)
<i>Peaking Factor</i>	-		<i>1.7 x ADD</i>	<i>3.78 x ADD</i>
Water Supply Assessment (RRM)	358	0.32	0.54	1.21
2007 Water Master Plan Demand Factors	512	0.46	0.78	1.73
10-year Production Average Demand Factors (as applied in 2020 UWMP)	352	0.31	0.53	1.19
5-year Production Average Demand Factors	316	0.28	0.48	1.07

1. All average day demand values include a 10% contingency per the method used in the Water Supply Assessment.

Total demands for existing and future conditions within the District system, including anticipated demands from the Dana Reserve development, were compared with the future delivery capacity from the Nipomo Supplemental Water Project and groundwater allocation in **Table 2-8**.

Table 2-8: Water Supply Allocation and Demand

Source	Existing Conditions with Deliveries to Purveyors	Maximum Anticipated Infill Development
	AFY	AFY
Average District Demand ¹	2,048	2,048
Potential District Maximum Anticipated Infill	-	340
Dana Reserve Demand	352	352
WMWC Demand ²	417	417
GSWC Demand ²	208	208
GSWCCR Demand ²	208	208
Total Demand	3,233	3,573
2025 NSWP Allocation	2,500	2,500
NCSD Voluntary Groundwater Reduction Goal ³	1,267	1,267
Total Future Water Supply	3,767	3,767
Supply Surplus / (Deficit)	534	194
NSWP New Development Allocation ⁴	500	500
Maximum Future Water Supply	4,267	4,267
Notes: 1. Table 4-1, 2020 UWMP. 2. 2025 purveyor wholesale estimate, Table 4-3, 2020 UWMP 3. NCSD current voluntary groundwater reduction goal based on fifty percent reduction from average production in the FY's 2009-10 through 2013-14 as required by the Final Judgment, or fifty percent of 2,533 AFY. 4. While this additional allocation is available to the District for delivery under the Wholesale Agreement, it should only be taken as a last resort. After the District requests 3000 AFY, the District must maintain that delivery. It is believed the District does not have enough demand to warrant additional water delivery past 2500 AFY.		

This analysis estimates that in 2025, even with the Dana Reserve Project, District water supplies will exceed demand by 534 AFY under existing conditions (with delivery to purveyors) and by 194 AFY under the Maximum Anticipated Infill Development scenario. If the District elects to take the New Development Allocation of 500 AFY, the remaining supply surplus will increase. A considerable challenge facing the District will be maintaining the currently operating wells within the system while continuing to meet contractual obligations for NSWP water deliveries. This is addressed in the storage discussion in Section 2.4.

2.2 Water System Facilities

2.2.1. Existing Facilities

The District’s existing water system includes the following supply, storage, and distribution facilities:

Supply

- Nipomo Supplemental Water Supply: Joshua Road Pump Station currently operating between 550 and 820 GPM with capacity to operate at 1,860 GPM (3,000 AFY).
- Sundale Well: Currently operating at 890 GPM.
- Via Concha Well: Currently operating at 610 GPM.
- Black Lake Well #4: Currently operating at 360 GPM.
- Knollwood Well: Currently operating at 240 GPM.
- Eureka Well #2: Currently inoperable. Future design capacity of 1000 GPM (To be online by 2022).

Storage

- Foothill Tanks: 4 tanks totaling 3,000,000 gallons of useful storage.
- Standpipe: 280,000 gallons of useful storage.
- Joshua Road Tank: 500,000 gallons; No useful storage for District system since it is a partially-buried tank intended primarily as operational buffer for Joshua Road Pump Station. Flow from the Tank must be pumped into the District system.

Distribution

- Pipeline Statistics:

The following table summarizes pipe lengths in the distribution system as extracted from District’s Water System GIS. The majority of pipelines (67%) are 8-inch diameter and smaller.

Table 2-9: Existing Water Pipeline Statistics		
Pipe Diameter (inches)	Pipe Length (feet)	% of Total
2	120	0.02%
4	1,189	0.24%
6	121,722	24.18%
8	215,531	42.82%
10	81,703	16.23%
12	48,052	9.55%
14	1,265	0.25%
16	22,746	4.52%
18	101	0.02%
24	10,898	2.17%
Total	503,327	100%

2.2.2. Proposed Master Plan Facilities

MKN reviewed the District's 2007 Water and Sewer Master Plan (Master Plan) for potential proposed improvements that may be necessary to support the development. Of the proposed improvements, the following were identified:

- 12" pipeline along Northeastern length of proposed Dana Reserve development from the corner of Sandydale Drive and North Frontage Road to Willow Road to loop the water system.
- 16" pipeline from the Foothill Tanks to Sandydale Drive and North Frontage Road. The pipeline was reduced from the 24" diameter originally proposed in the WMP. A 16" pipeline is more appropriate given the updated future demands and flows necessary to meet District demand as a result of future development and the Dana Reserve Project.

As an alternative, District staff recommended MKN evaluate a 16-inch pipeline on North Oakglen Avenue from West Tefft Street to Sandydale Drive and North Frontage Road.

2.3 Hydraulic Analysis Results and Recommendations

2.3.1. Hydraulic Modeling Analysis

MKN utilized the District's current WaterCAD hydraulic model to evaluate the impact of the proposed Dana Reserve development on the existing and future District water system based on existing and future projected demands.

For the purpose of this report, scenarios were modeled for both current and future conditions within the District's Water System. All scenarios assumed delivery to the Woodlands Mutual Water Company (WMWC), Golden State Water Company (GSWC), and Golden State Water Company Cypress Ridge (GSWCCR) as outlined in **Table 2-4**. The existing conditions scenarios also assumed a delivery of 1,336 gpm (2,157 AFY) from the NSWP at the Joshua Road Pump Station (JRPS), which is based on the District's current delivery from JRPS (820 gpm) plus future required deliveries to other purveyors (516 gpm total). Model runs were performed under steady state conditions based on the following model settings:

- Existing System Demands
 - Average day demand (ADD) conditions: 1850 gpm
 - Maximum day demand (MDD) conditions: 2,784 gpm (1.7 peaking factor)
 - Peak hour demand (PHD) conditions: 5,559 gpm (3.78 peaking factor)
 - Residential fire-flow: 1,000 gpm per 2016 California Fire Code
 - Commercial fire-flow: 3,000 gpm
- Delivery to WMWC at Trail View Place: 258 gpm (417 AFY)
- Delivery to GSWC at Primavera Lane: 129 gpm (208 AFY)
- Delivery to GSWCCR at Lyn Road: 129 gpm (208 AFY)
- Joshua Road Pump Station at 1336 gpm (2157 AFY)
- Available Well Production
 - Blacklake #4: 360 gpm
 - Knollwood: 240 gpm

- Sundale: 890 gpm
- Via Concha: 610 gpm
- Foothill Tanks in service
 - Tank level during ADD: 17 feet (540 feet)
 - Tank level during MDD: 15 feet (538 feet)
 - Tank level during PHD: 13 feet (536 feet)
- Standpipe in service
 - Tank level during ADD: 80.4 feet (540 feet)
 - Tank level during MDD: 78.4 (538 feet)
 - Tank level during PHD: 76.4 (536 feet)

The scenarios were assessed based on the following criteria, in conjunction with current District Standards and Specifications for Water System Design:

- System Pressure
 - Minimum Operating Pressure (ADD, MDD, PHD) = 40 psi
 - Minimum Operating Pressure (MDD plus fire-flow) = 20 psi
 - Maximum Recommended Operating Pressure (All conditions) = 80 psi
- Pipeline Velocity
 - Maximum Pipeline Velocity (All conditions – as a goal not a requirement) = 5 ft/s

Table 2-10 provides a description of Scenarios 1 through 9 and results of the analysis for baseline conditions as well as existing conditions with the addition of the proposed Dana Reserve Development. Modeled system pressures were observed at the following nine locations within the District’s water distribution system to identify pressure impacts to the District’s low pressure service area customers, high pressure service area customers, interconnection with WMWC, interconnection with GSWC, interconnection with GSWCCR, and four locations within the Dana Reserve development:

- Low Pressure (high elevation) Area in Summit Station: Futura Lane
- High Pressure (low elevation) Area in Main Zone: Honeygrove Lane
- WMWC Interconnection: Trail View Place
- GSWC Interconnection: Primavera Lane
- GSWCCR Interconnection: Lyn Road west of Red Oak Way
- Dana Reserve Connection: Sandydale Drive
- Dana Reserve Connection: Pomeroy Road
- Dana Reserve Connection: Willow Road (west)
- Dana Reserve Connection: Willow Road (east)

Table 2-10: Hydraulic Analysis Scenarios 1-9

Table 2-10: Hydraulic Modeling Results with NSWP Delivery at 2157 AFY

WaterCAD Scenario and Settings							Dana Reserve Delivery	Futura Lane (EL = 454')	Honeygrove Lane (EL = 306')	Dana Reserve at Sandydale Drive (EL = 355')	Dana Reserve at Pomeroy Road (EL = 351')	Dana Reserve at Willow Road 1 (EL = 385')	Dana Reserve at Willow Road 2 (EL = 378')	WMCC Interconnect at Trail View Place (EL = 222')	GSWC Interconnect at Primavera Lane (EL = 312')	GSWCCR Interconnect at Lyn Road (EL = 328')
Scenario	Description	Total Demand (GPM)	NSWP Delivery (GPM)	Wells	Quad Tanks Level (Feet)	Standpipe Level (Feet)	Flow (GPM)	Pressure (PSI)	Pressure (PSI)	Pressure (PSI)	Pressure (PSI)	Pressure (PSI)	Pressure (PSI)	Pressure (PSI)	Pressure (PSI)	Pressure (PSI)
Baseline System Conditions without Delivery to Dana Reserve																
1	Average Day Demand	1850	1336	Off	17	80.4	-	37	102	80	81	-	-	137	99	91
2	Maximum Day Demand	2784	1336	Off	15	78.4	-	37	101	79	81	-	-	136	98	91
3	Maximum Day Demand + 1000 GPM Fire-flow at Futura Lane	3784	1336	Off	15	78.4	-	19.9	101	79	80	-	-	136	98	80
4	Peak Hour Demand	5559	1336	Off	13	76.4	-	36	93	72	73	-	-	129	91	90
System Conditions with Delivery to Dana Reserve																
5	Average Day Demand	2069	1336	Off	17	80.4	218	37	102	80	81	67	70	137	99	91
6	Maximum Day Demand	3155	1336	Off	15	78.4	371	36	99	78	79	65	68	135	97	90
7	Maximum Day Demand + 1000 GPM Fire-flow at Futura Lane	4155	1336	Off	15	78.4	371	19	99	78	79	65	67	135	97	79
8	Maximum Day Demand + 3000 GPM Fire-flow at Dana Reserve	6155	1336	Off	15	78.4	3371	35	92	68	70	54	57	127	90	89
9	Peak Hour Demand	6383	1336	Off	13	76.4	824	34	89	56	58	68	70	125	87	88

Legend:

- Falls within recommended range
- Falls under recommended pressure (40 psi for ADD, MDD, PHD; 20 psi for Fire-flow)
- Exceeds recommended pressure (80 psi for all scenarios)

Scenarios 1 through 4: Existing System Conditions

Scenarios 1-4 modeled existing pressures at the nine monitoring locations with NSWV delivery at 820 gpm, all storage tanks in service, and no wells in service under ADD, MDD, MDD plus fire-flow, and PHD conditions. Pressures throughout the water system under existing conditions vary slightly between ADD, MDD, MDD plus fire-flow, and PHD, but largely remain within the District's recommended pressure ranges. The District's high point, Futura Lane, faces pressures below the District's recommended range during all existing system condition scenarios. All purveyor interconnection sites experience high pressures (above 80 psi) throughout most existing system condition scenarios.

Scenarios 5 through 9: Existing System Conditions with Dana Reserve Addition

Results from Scenarios 5 through 9 show a minor decrease in system pressures (1-2 psi) during MDD plus fire-flow and PHD conditions across much of the system when compared to those same scenarios during existing conditions.

Figure 2-1 outlines the developer proposed water mains as well as four proposed improvement alternatives to mitigate the system impact made by the Dana Reserve Development. The impacts these alternatives have on the District's system in conjunction with increased future system demands were assessed in the hydraulic modeling analysis and are included in **Table 2-11** and the discussion to follow.

Table 2-11 summarizes Scenarios 10 through 23 and results of the analysis for future demands based on maximum anticipated infill development and increased NSWV delivery. These scenarios also included potential improvement projects in the analysis. The same assumptions were used as stated previously except for the following:

- Future System Demands
 - Average day demand (ADD) conditions: 2,277 gpm
 - Maximum day demand (MDD) conditions: 3,509 gpm (1.7 peaking factor)
 - Peak hour demand (PHD) conditions: 7,170 gpm (3.78 peaking factor)
- Joshua Road Pump Station at 1,550 gpm (2,500 AFY)



Nipomo Community Services District

Dana Reserve Development - Water and Wastewater Service Evaluation

Figure 2-1

Proposed Pipeline Improvements for District Water System



1 inch = 1,500 feet

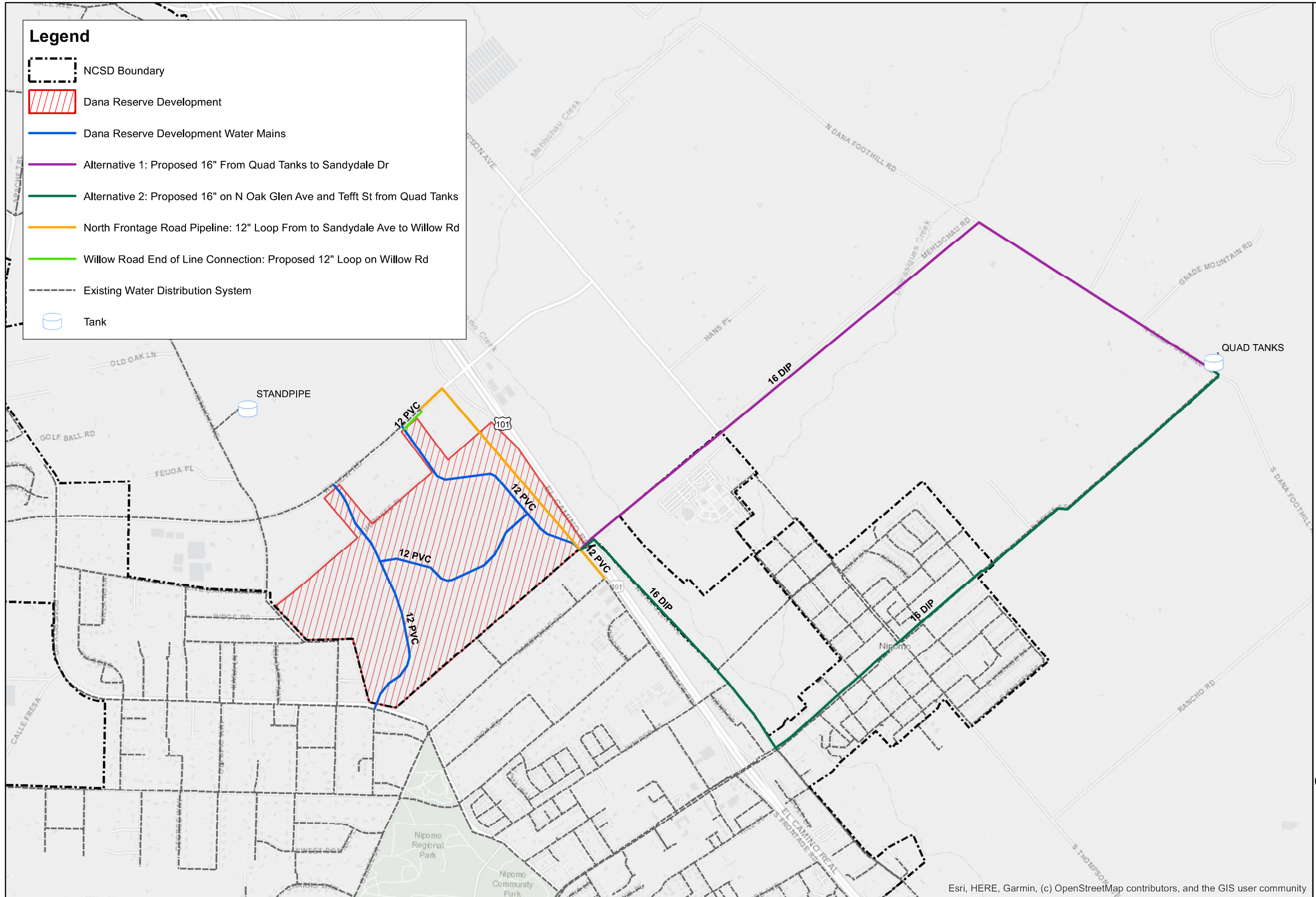
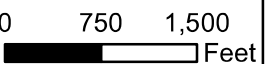

Legend









-  NCSD Boundary
-  Dana Reserve Development
-  Dana Reserve Development Water Mains
-  Alternative 1: Proposed 16" From Quad Tanks to Sandydale Dr
-  Alternative 2: Proposed 16" on N Oak Glen Ave and Tefft St from Quad Tanks
-  North Frontage Road Pipeline: 12" Loop From to Sandydale Ave to Willow Rd
-  Willow Road End of Line Connection: Proposed 12" Loop on Willow Rd
-  Existing Water Distribution System
-  Tank

Table 2-11: Dana Reserve Hydraulic Modeling Results with NSWP Delivery at 2500 AFY

WaterCAD Scenario and Settings							Dana Reserve Delivery	Futura Lane (EL = 454')	Honeygrove Lane (EL = 306')	Dana Reserve at Sandydale Drive (EL = 355')	Dana Reserve at Pomeroy Road (EL = 351')	Dana Reserve at Willow Road 1 (EL = 385')	Dana Reserve at Willow Road 2 (EL = 378')	WMCC Interconnect at Trail View Place (EL = 222')	GSWC Interconnect at Primavera Lane (EL = 312')	GSWCCR Interconnect at Lyn Road (EL = 328')
Scenario	Description	Total Demand (GPM)	NSWP Delivery (GPM)	Wells	Quad Tanks Level (Feet)	Standpipe Level (Feet)	Flow (GPM)	Pressure (PSI)	Pressure (PSI)	Pressure (PSI)	Pressure (PSI)	Pressure (PSI)	Pressure (PSI)	Pressure (PSI)	Pressure (PSI)	Pressure (PSI)
System Conditions with Delivery to Dana Reserve and Future Flows Based on Subdivision Potential																
10	Average Day Demand	2277	1550	Off	17	80.4	199	37	102	80	81	67	70	137	102	91
11	Maximum Day Demand	3509	1550	Off	15	78.4	339	36	101	78	80	65	68	136	99	90
12	Maximum Day Demand + 1000 GPM Fire-flow at Futura Lane	4509	1550	Off	15	78.4	339	19	101	78	80	65	68	135	98	79
13	Maximum Day Demand + 3000 GPM Fire-flow at Dana Reserve	6509	1550	Off	15	78.4	3339	35	92	68	70	54	57	126	90	89
14	Maximum Day Demand + 3000 GPM Fire-flow at Dana Reserve & NO JRPS	6509	0	Off	15	78.4	3339	34	85	63	65	50	53	122	83	89
15	Peak Hour Demand	7170	1550	Off	13	76.4	754	33	92	70	72	58	60	127	90	87
16	Peak Hour Demand	7170	1550	All Wells On	13	76.4	754	34	97	76	78	63	66	137	95	88
System Conditions with Delivery to Dana Reserve and Future Flows Based on Subdivision Potential with Proposed 16" Pipeline From Quad Tanks																
17	Maximum Day Demand + 3000 GPM Fire-flow at Dana Reserve	6509	1550	Off	15	78.4	3339	35	97	73	75	59	62	131	95	89
System Conditions with Delivery to Dana Reserve and Future Flows Based on Subdivision Potential with Proposed 16" Pipeline on N Oak Glen and Tefft																
18	Maximum Day Demand + 3000 GPM Fire-flow at Dana Reserve	6509	1550	Off	15	78.4	3339	35	95	73	74	58	62	130	93	89
System Conditions with Delivery to Dana Reserve and Future Flows Based on Subdivision Potential without 10" Pipeline from Quad Tanks on Tefft																
19	Maximum Day Demand + 3000 GPM Fire-flow at Dana Reserve	6509	1550	Off	15	78.4	3339	35	93	68	70	54	57	127	90	89
20	Maximum Day Demand + 3000 GPM Fire-flow at Dana Reserve & NO JRPS	6509	0	Off	15	78.4	3339	34	80	59	61	45	48	117	78	88
System Conditions with Delivery to Dana Reserve and Future Flows Based on Subdivision Potential with Proposed 12" Loop on North Frontage from Sandydale to Willow																
21	Maximum Day Demand + 1000 GPM Fire-flow at Futura Lane	4509	1550	Off	15	78.4	339	19	101	78	80	65	68	135	98	79
22	Maximum Day Demand + 3000 GPM Fire-flow at Dana Reserve	6509	1550	Off	15	78.4	3339	35	95	70	72	56	59	128	93	89
23	Peak Hour Demand	7170	1550	Off	13	76.4	754	33	92	70	72	58	60	127	90	87
System Conditions with Delivery to Dana Reserve and Future Flows Based on Subdivision Potential with Proposed 12" End-of-Line Loop on Willow																
24	Maximum Day Demand + 3000 GPM Fire-flow at Dana Reserve	6509	1550	Off	15	78.4	3339	35	92	68	70	54	57	126	90	89

Legend:

- Falls within recommended range
- Falls under recommended pressure (40 psi for ADD, MDD, PHD; 20 psi for Fire-flow)
- Exceeds recommended pressure (80 psi for all scenarios)

Scenarios 10 through 16: Future System Conditions with Dana Reserve Addition

System pressures at the monitoring locations increased by 1-2 psi for flow conditions with the higher demands and NSWP delivery (3000 AFY) compared to existing system conditions. Futura Lane remains consistently below allowable system pressures for all conditions except MDD plus fire-flow at Dana Reserve, which is consistent with the existing conditions scenarios. It should be noted that the worst-case scenario run, MDD plus fire-flow conditions at Dana Reserve (3000 gpm) with JRPS not operating, still yielded acceptable pressures at all monitored nodes.

Scenario 17: Future System Conditions with Dana Reserve Addition and Proposed Alternative 1

Alternative 1 includes a 16" pipeline from the Foothill Tanks to the connection point at Dana Reserve as shown in **Figure 2-1**. This scenario was performed assuming MDD plus fire-flow conditions at Dana Reserve (3000 gpm) and improves system pressures by 2-3 psi at all nodes except for Futura Lane and the GSWCCR Interconnection. This improvement was modified from the original 24" Master Plan improvement recommended to account for low pipeline velocities.

Scenario 18: Future System Conditions with Dana Reserve Addition and Proposed Alternative 2

Alternative 2 includes a 16" pipeline on North Oak Glen Avenue from Tefft Street to the connection point at Dana Reserve, and the replacement of the 10" AC pipeline on Tefft with a new 16" ductile iron pipe as shown in **Figure 2-1**. This scenario was performed assuming MDD plus fire-flow conditions at Dana Reserve (3000 gpm) and the pipeline improves system pressures by 1-2 psi at the Dana Reserve site, but lowers system pressures by less than 1 psi at Honeygrove Lane (low elevation system location) and the WMCC Interconnection. It should be noted that both of those nodes are consistently above recommended system pressures for the District system, so lower pressures at these sites are of less concern.

Scenarios 19 through 20: Future System Conditions with Dana Reserve Addition and Without 10" Pipeline from Foothill Tanks on Tefft (Proposed Alternative 2)

These scenarios were run performed to demonstrate the degree to which the District relies on the 10" and 12" pipelines running from the Foothill Tanks to the rest of the District's distribution system. The 10" pipeline is asbestos cement and is over 50 years old (originally installed in 1966). These scenarios assumed MDD plus fire-flow at Dana Reserve (3000 gpm) condition and the same condition without JRPS online, to demonstrate the effects on the distribution system without NSWP delivery and with limited flow from the Foothill Tanks. The first scenario lowers system pressures by 1-3 psi across the system, and most significantly impacted the Dana Reserve development. This scenario increased the pipeline velocity in the parallel 12" pipeline coming from the Foothill Tanks, but not above the District's limit of 5 ft/s. Scenario 20 without JRPS online decreased system pressures by 10-15 psi when compared to Scenario 13 (Future System Conditions at MDD plus fire-flow at Dana Reserve). This scenario also increased the pipeline velocity in the parallel 12" pipeline coming from the Foothill Tanks to approximately 6.08 ft/s, exceeding the maximum recommended velocity outlined by the District Standards.

Scenarios 21 through 23: Future System Conditions with Dana Reserve Addition and North Frontage Road Pipeline

These scenarios analyze approximately 4750 LF of 12" pipeline along North Frontage Road to the existing dead-end on Willow Road as shown in **Figure 2-1**. Results from these scenarios indicate that this pipeline will not improve system pressures by a significant margin, however, this improvement promotes looping from the tanks to Dana Reserve which is an important benefit to eliminate dead end water mains and minimize water age throughout the system. The District requires looping of water mains to prevent dead ends.

Scenario 24: Future System Conditions with Dana Reserve Addition and Willow Road End-of-Line (EOL) Connection

This scenario includes a 12" loop on Willow Road to prevent a dead-end line on Willow Road as an alternative to the North Frontage Road Pipeline as shown in **Figure 2-1**. This alternative causes no change to system pressures shown in Scenario 13 (Future System Conditions at MDD plus fire-flow at Dana Reserve) but does satisfy District looping requirements with minimal off-site improvements.

2.3.2. Recommended Offsite Pipeline Improvements

The hydraulic analysis indicated that the Dana Reserve development will likely impact the District's water distribution system most significantly during MDD plus fire-flow at Dana Reserve and PHD conditions with minor decreases of less than 1 psi under other ADD and MDD conditions. The District should consider either Alternatives 1 or 2 to ensure reliable water delivery and adequate pressures throughout their system with the addition of the Dana Reserve Development.

1. **Alternative 1:** Construction of the new 16-inch pipeline (shown in Figure 2-1) from the Foothill Tanks to the Sandydale connection point would allow the District to maintain high system pressures during MDD plus fire-flow conditions at Dana Reserve and provide an additional freeway crossing, adding redundancy to the existing distribution system.
2. **Alternative 2:** Construction of the new 16-inch pipeline on North Oak Glen Drive from Tefft Street to the Sandydale connection point; and replacement of the existing 10-inch AC pipeline from the Foothill Tanks to North Oak Glen Drive on Tefft Street with a new 16-inch PVC pipeline (shown in Figure 2-1). These improvements would allow the District to maintain high system pressures during MDD plus fire-flow conditions at Dana Reserve and provide an additional freeway crossing, adding redundancy to the existing distribution system (shown in Figure 2-1). These improvements would also provide redundancy to the District's water supply from the Foothill Tanks. The existing 10-inch is at high risk of failure because of the age of the pipeline. This pipeline also provides much of the system's water supply, and if it were to fail, pressures would fall across the system.

2.3.3. Evaluation of Proposed Onsite Pipeline Improvements

The Developer proposed four connection points for the Dana Reserve water system based on anticipated projects. However one proposed connection does not connect to the District's existing system. As such, it is recommended that the southeast connection point be moved to the intersection of Sandydale Drive and North Frontage Road.

Figure 2-1 shows the Developer-proposed water mains for the Dana Reserve development per the most recent copy of the Draft DRSP (April 2020). The proposed 12-inch mains are appropriate for maintaining District recommended pressures and velocities. **Figure 2-1** shows the North Frontage Road Pipeline that provides looping for the overall system and prevents a dead end on Willow Road. While looping is required to meet District standards, it is recommended the District pursue the Willow Road EOL Connection, outlined in **Figure 2-1**, to avoid a dead-end connection, while maintaining services at the end of the 12-inch line on Willow Road. This alternative maintains looping requirements but avoids unnecessary off-site improvements.

It should be noted that the Draft DRSP only identifies transmission mains to serve the Dana Reserve development, so the extent of onsite improvements that could be reviewed and modeled was limited. Further evaluation will be needed after preliminary design of onsite improvements is submitted by the developer.

2.4 Storage Analysis and Recommendations

Table 2-13 outlines the water system storage capacity for the District system under three scenarios, with and without the Dana Reserve Development. The first scenario represents existing conditions of the current District system based on current system demands and service population. The second scenario represents the maximum anticipated infill potential based on parcels that could be added to the District system, particularly those designated NCS D Reserved Capacity, those on private wells, and vacant parcels. This scenario assumes that those parcels that can subdivide will subdivide, increasing ADU potential. The final scenario represents the future conditions outlined in the Storage Capacity Analysis of the 2007 Water and Sewer Master Plan. This scenario anticipated the construction of 1,000,000 gallons of additional storage, increasing the overall system storage to a total of 4,280,000 gallons. The 2007 Water and Sewer Master Plan analysis also included Sundale Well as an emergency supply. It was assumed that Sundale Well could reliably produce 1,000 gpm of emergency water supply for a three-day period, which is equivalent to 3,710,000 gallons. This assumption is not valid if the wells are not operated sufficiently.

The District is required by State law (California Code of Regulations Title 22) to maintain sufficient water storage capacity within its system to meet three basic needs: fire storage, equalization storage, and emergency storage. Fire flow storage must be greater than that required to produce the maximum anticipated fire-flow for a specified duration. Equalization storage is necessary to maintain availability of demand during peak conditions when system demands are greater than that being fed directly from supply sources. Emergency storage must be on hand to produce at least 50 gallons per capita per day for three days.

Fire-flow storage is calculated by multiplying fire-fighting flowrate by the duration of the fire-fighting event. A 3,000 gallon per minute flowrate for a duration of three hours was used to determine the minimum fire storage required for the system (540,000 gallons). This minimum value was assumed to be equal for both existing and future conditions.

Equalization storage is estimated by the formula: $(1.5 - 1) \times (\text{MDD in GPM}) \times (14 \text{ hours}) \times (60 \text{ minutes per hour})$. The calculated values are displayed in **Table 2-13** for three scenarios.

Emergency storage is calculated by multiplying population by 50 gallons per day for three days. Existing population within the NCS D service area is estimated at 13,771 for the year of 2020 as calculated using the Department of Water Resources (DWR) Population Tool. Existing and future population projections from the 2020 DWR service population estimates are shown in **Table 2-12**, including future projections from the 2020 UWMP.

Table 2-12: NCS D Served Population Summary		
Conditions	2020 Population	2045 Population with Maximum Anticipated Infill Development
District Service Area	13,771	16,031
District Service Area with Dana Reserve Project	13,771	18,398
Notes:		
1. Per Tables 3-1 and 3-1a from the District's 2020 UWMP update.		

Table 2-13: Water System Storage Capacity			
Storage Requirements	Existing Conditions¹	Existing Conditions with Dana Reserve	Maximum Anticipated Infill Development² with Dana Reserve
	gallons	gallons	gallons
Fire	540,000	540,000	540,000
Equalization	952,489	1,108,198	1,256,843
Emergency	2,065,650	2,486,250	2,550,600
Total	3,558,139	4,134,448	4,347,443
Existing Above-Ground Storage Capacity	3,280,000	3,280,000	3,280,000
Gross Surplus/(Deficiency)	(278,139)	(854,448)	(1,067,443)
Notes: 1. Existing conditions based on 2019 NCS D customer usage data. 2. Maximum anticipated infill development based on current land development status and potential future development status.			

The District’s existing tank storage is not adequate to meet current and future needs including the Dana Reserve. While current storage does not adequately provide storage for existing conditions, the addition of Dana Reserve increases the storage need by almost 577,000 gallons.

As delivery from the NSWP increases, the District will require more operational storage for the water distribution system. Unlike wells, which can be sequenced to match daily diurnal usage fluctuations, the NSWP delivers constant flow into the District system. This requires additional equalization or “buffer” storage to prevent overflowing tanks or draining them below typical operating levels. As the District continues to operate their existing groundwater wells, the District will operate them during times when the cost for energy is low, which typically falls during low water demand hours (late night to early morning). This increased production during low consumption periods will dictate the District’s need for additional storage. It is recommended that the District invest in additional aboveground storage in order to maintain enough storage to improve flexibility in operating with higher NSWP deliveries alongside continued groundwater well pumping. The preferred location for new storage is at the Foothill Tanks site.

Adding the new 1.0 MG storage tank recommended in the Water Master Plan will require that the District purchase additional land. The expanded storage capacity will allow the District to meet the identified storage requirements and will provide redundancy. The additional tank will also facilitate tank maintenance as cleaning and recoating can require taking a tank out of service for months at a time. The addition of a new tank at the Foothill Tanks site would necessitate improvements to the District’s current chemical injection as well as valving between tanks. The current chemical injection system relies on manual injection of chemicals to the water stored in the elevated tanks. The construction of an additional storage tank would warrant automation and improvements to the existing chemical injection. It is also recommended that the District automate the current manual isolation valves between tanks to control water quality and manage constant flow from the NSWP.

Operational storage for NSWP delivery is another area of concern. The existing 500,000 gallon partially-buried reservoir at JRPS receives water from the City of Santa Maria. Pressure conditions in the City’s system can fluctuate, necessitating the inclusion of this reservoir to provide a constant water supply to JRPS. The reservoir is

one of the only major components of NSWP with no redundancy. If the existing JRPS Reservoir is taken out of service for repairs, cleaning or maintenance, NSWP may not have adequate supply from the City to operate which could leave the District unable to meet system demands. Adding a second 500,000-gallon reservoir at JRPS is recommended to provide redundancy in case the reservoir must be taken out of service for maintenance or repairs.

3.0 WASTEWATER COLLECTION SYSTEM

3.1 Wastewater Flows

3.1.1. Flow Monitoring

To aid in estimating existing wastewater flows and the distribution across the District wastewater collection system, MKN’s subconsultant, ADS, placed three (3) depth-velocity flow meters in the District’s collection system at locations indicated on **Figure 3-1**. MKN and District staff worked with ADS to identify manholes for placement. Five-minute depth and velocity data were collected between October 23, 2020, and November 28, 2020 and converted to flow in gallons per minute (GPM). The report from ADS (Appendix A) describes the flow meter type and data collection methodology and provides graphs of calculated flows at each location.

The sewershed upstream of Flow Meter No. 1 (FM01) includes contributions from the two other flow meters (FM02 and FM03).

The flow conditions used throughout the next two sections of the Study are defined below.

- *Average Annual Flow (AAF)*: The flow rate averaged over the course of the year and the base flow for the collection system and WWTF.
- *Average Daily Flow (ADF)*: The flow rate averaged by day over a monitoring period.
- *Maximum Month Flow (MMF)*: The average daily flow during the month with the maximum cumulative flow. MMF is often the basis for a WWTF permitted flow limit.
- *Peak Day Flow (PDF)*: The maximum daily flow rate used to design or evaluate hydraulic retention times for certain wastewater treatment processes.
- *Peak Hour Flow (PHF)*: The maximum one-hour flow experienced by the facility is typically used for sizing collection system mains, WWTF piping, pump stations, flow meters and WWTF headworks systems. Peak hour flow is typically derived from facility influent records, flow monitoring, or empirical equations used to estimate PHF based on service area population.

The following table summarizes results for each flow meter during the flow monitoring period.

Parameter	Units	Flow Meter		
		FM01	FM02	FM03
Pipe Diameter	Inches	24	12	10
Average Daily Flow	GPD	560,000	191,000	74,000
Average Daily Flow	GPM	389	133	52
Average Flow Depth	Inches	4.75	2.95	2.25
Peak Hour Flow	GPM	747	258	101
Peak Hour Flow Depth	Inches	5.08	3.00	2.32
Peak Hour Peaking Factor (PHF/ADF)	-	1.9	1.9	1.9
Peak Instantaneous Flow (5-minute data)	GPM	875	643	172

Results for FM01 during the study period were compared to flows at the Southland WWTF influent flow meter during the study period and between January 2019 and December 2020.

Table 3-2: Historical Southland WWTF Influent Flow and Loading (January 2019 – December 2020)		
Parameter	Unit	Value
Average Flow During Study Period (Oct/Nov 2020)	MGD	0.50
Average Annual Flow (AAF)	MGD	0.49
Maximum Month Flow (MMF)	MGD	0.51
Peak Day Flow (PDF)	MGD	0.57
Peak Hour Flow (PHF) ¹	MGD	1.3

¹ Peak hour was determined from data collected between July 2018 and June 2020 for another study being conducted by the District.



Nipomo Community Services District

Dana Reserve Development - Water and Wastewater Service Evaluation

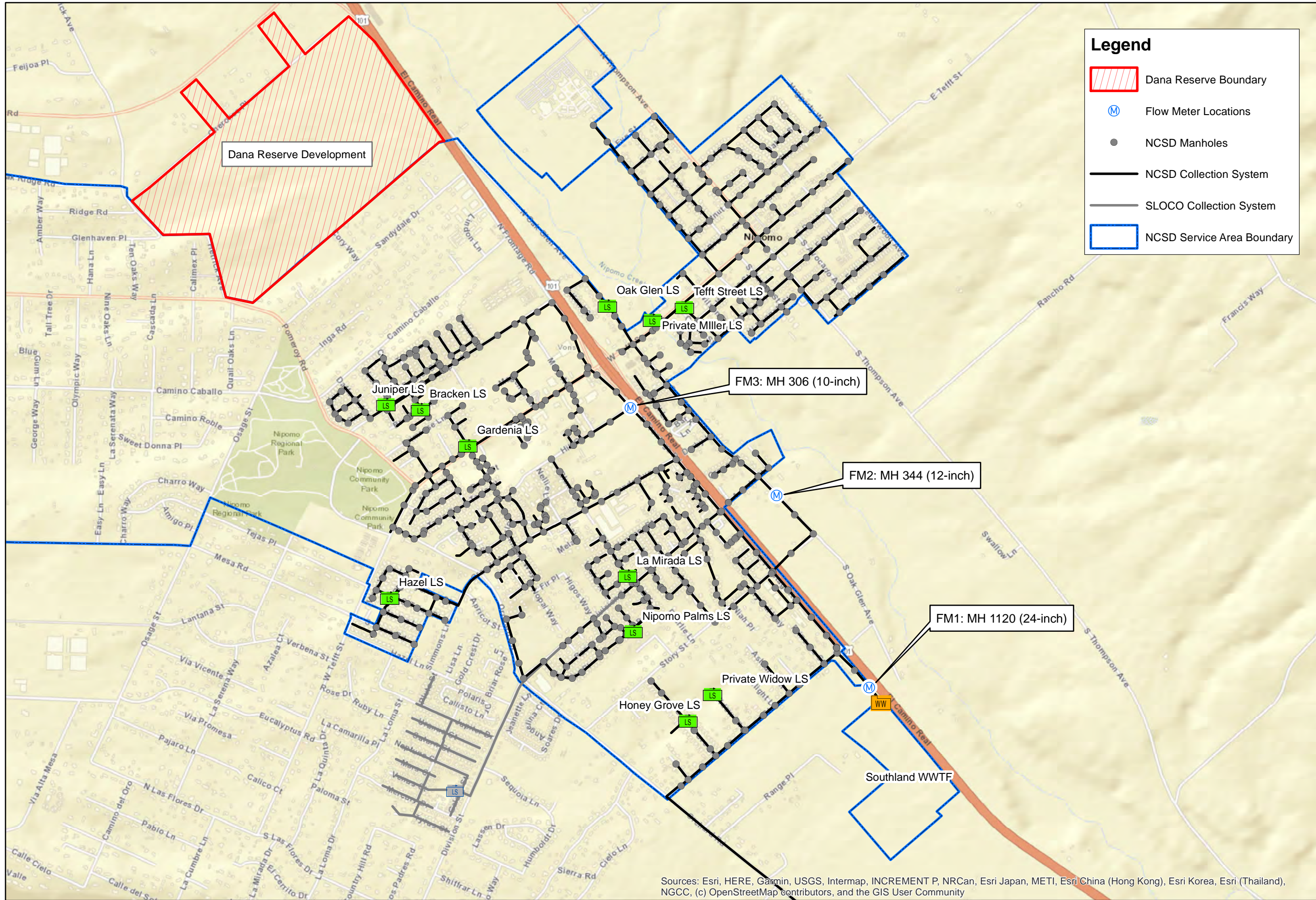
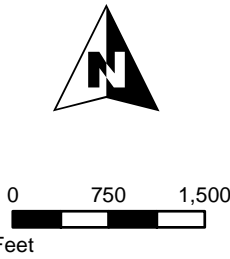

Figure 3-1:

Flow Meter Locations



Sources: Esri, HERE, Garmin, USGS, Intermap, INCREMENT P, NRCan, Esri Japan, METI, Esri China (Hong Kong), Esri Korea, Esri (Thailand), NGCC, (c) OpenStreetMap contributors, and the GIS User Community

3.1.2. District Projections

The District includes two wastewater service areas: Town and Blacklake. District staff is developing the Blacklake Sewer Consolidation Project to regionalize wastewater treatment at a central District facility. Existing influent wastewater from the Blacklake sewer collection system will be diverted from the Blacklake Water Reclamation Facility (WRF) to the Southland Wastewater Treatment Facility (WWTF). This project will require installation of a lift station at the existing Blacklake WRF site and construction of a force main to convey wastewater from the Blacklake system to the Town Sewer system for conveyance and treatment at the Southland WWTF. The existing Blacklake WRF will be decommissioned.

County sewer customers are also connected to the Town System through the Galaxy and People’s Self Help (PSH) Lift Stations. These customers are identified separately in **Table 3-4**.

Future District projections in **Table 3-5** include both Blacklake and Town service areas since both will be served in the future. District GIS has identified parcels which are not yet tied into District sewer mains but could be served in the future, therefore these parcels were included. Two different methods were considered to estimate future AAF:

- Method 1: Return flows applied to 10-year (2011-2020) water production records².
- Method 2: Duty factors from the 2007 Water and Sewer Master Plan Update

Method 1 results were developed from average daily demand (ADD) calculated as described in Section 2.1 for the Maximum Anticipated Infill Development Scenario and potential ADUs with return factors applied based on land use of each parcel. Return factors are summarized in the table below.

Table 3-3: Sewer Flow Return Factors by Land Use	
Land Use	Sewer Flow Return Factor (%)
Agriculture	-
Commercial Retail	90%
Commercial Service	90%
Multi-Land Use Category	90%
Office and Professional	90%
Open Space	65%
Public Facility	65%
Recreation	-
Rural Lands	-
Residential Multi-Family	90%
Residential Rural	90%
Residential Suburban	50%
Residential Single Family	60%

² Historical demands by parcel, based on billing records, were adjusted using the 10-year production average. These demands by individual parcel were then used to calculate water usage factors per acre based on land use category.

Both methods are summarized below for the entire Town Sewer service area, including the County service areas. Both methods are also compared to the flow metering results discussed in Section 3.1.

Table 3-4: Estimated Total Existing Sewer Flows								
Land Use	No. of Sewered Parcels	Area (Ac)	% of Total	10-yr Water Production (gpd)	% of Total	Return Factor (%)	Estimated Sewer Flow based on Return Factors (gpd)	Estimated Sewer Flow with MP Sewer Factors (gpd)
Commercial Retail	3	57	7%	76,154	9%	90%	68,538	61,113
Commercial Service	9	8	1%	3,463	0%	90%	3,117	2,032
Multi-Land Use Category	1	3	0%	359	0%	90%	323	0
Office and Professional	18	5	1%	2,993	0%	90%	2,693	942
Public Facility	5	12	1%	4,139	0%	65%	2,691	5,188
Rural Lands	1	3	0%	271	0%	0%	-	0
Recreation	1	122	16%	86,473	10%	0%	-	0
Residential Multi-Family	525	72	9%	158,783	19%	90%	142,905	189,711
Residential Suburban	112	39	5%	21,382	3%	50%	10,691	12,817
Residential Single Family	1,878	384	49%	479,332	58%	60%	287,599	354,371
Agriculture	1	79	10%	0	0%	0%	-	0
Subtotal	2,554	783	100%	833,349	1	-	518,557	626,173
County Service Areas							72,662	77,074
Total Estimated Flow							591,219	703,247
Measured Flow							559,673	559,673
% Difference							5%	23%

Table 3-5 summarizes future flow estimates under both methods described above.

Table 3-5: Projected Future Sewer Flows (Not including Existing)

Land Use	No. of Sewered Parcels	Area (Ac)	% of Total	10-Yr Water Production (gpd)	% of Total	Return Factor (%)	Estimated Sewer Flow with Return Factor (gpd)	Estimated Sewer Flow with MP Sewer Factors (gpd)
Commercial Retail	62	71	15%	94,467	21%	90%	85,021	75,810
Commercial Service	11	49	10%	21,710	5%	90%	19,539	12,739
Multi-Land Use Category	0	0	0%	0	0%	90%	0	0
Office and Professional	14	9	2%	5,548	1%	90%	4,993	1,746
Public Facility	2	12	2%	4,114	1%	65%	2,674	5,096
Rural Lands	0	0	0%	0	0%	0%	0	0
Recreation	0	0	0%	0	0%	0%	0	0
Residential Multi-Family	29	38	8%	60,244	13%	90%	54,221	100,939
Residential Suburban	91	132	28%	96,198	21%	50%	86,578	43,542
Residential Single Family	169	153	33%	165,158	37%	60%	148,644	141,490
Agriculture	0	0	0%	0	0%	0%	0	0
Subtotal	378	464	100%	447,439	100%	-	401,669	381,362
Blacklake WRF¹							58,000	58,000
Future ADUs							26,161	26,161
Total Flows							485,830	465,523
Notes:								
1. Blacklake WRF will be decommissioned in the future with flows going to Southland WWTP instead. Future flow from the 2017 Blacklake Sewer Master Plan (MKN) was used.								

Flow meter results were compared to estimated existing flows as shown in the following tables to calibrate the District’s sewer model. Existing flows were estimated by applying the return factors to water billing records for each customer. The readings at FM01 and FM02, the largest sewersheds, were significantly closer to modeled AAF estimates than FM03 (3.4% and 0% compared to 28%). FM03 only represented 13% of the measured flow. Since the flow monitoring represented a limited period, but monthly flows at Southland WWTF do not vary significantly from AAF, the flow monitoring results indicate Method 1 and the assumed return factors are adequate for modeling sewer system flows in each sewershed.

Table 3-6: Estimated Sewer Flow for FM01 Basin

Existing							
Land Use	No. of Sewered Parcels	Area (Ac)	% of Total	Water Usage (gpd)	% of Total	Reduction Factor (%)	Estimated Sewer Flow (gpd)
Commercial Retail	3	5	2%	6,533	2%	90%	5,879
Commercial Service	9	8	3%	3,463	1%	90%	3,117
Multi-Land Use Category	1	3	1%	359	0%	90%	323
Public Facility	1	0	0%	0	0%	65%	-
Rural Lands	1	3	1%	271	0%	0%	-
Residential Multi-Family	317	43	17%	95,760	29%	90%	86,184
Residential Suburban	86	35	13%	19,181	6%	50%	9,591
Residential Single Family	777	166	63%	206,869	62%	60%	124,122
Subtotal	1,195	262	100%	332,437	100%	--	229,216
County Service Areas							72,662
Total							301,877
FM01-(FM02+FM03) Measured Flow (gpd)							294,355
% Difference							3.4%

Table 3-7: Estimated Sewer Flow for FM02

Existing							
Land Use	No. of Sewered Parcels	Area (Ac)	% of Total	Water Usage (gpd)	% of Total	Reduction Factor (%)	Estimated Sewer Flow (gpd)
Commercial Retail	41	24	8%	31,648	12%	90%	28,484
Commercial Service	0	0	0%	0	0%	90%	0
Office and Professional	18	5	2%	2,993	1%	90%	2,693
Public Facility	4	12	4%	4,139	2%	65%	2,691
Residential Multi-Family	184	27	9%	59,391	22%	90%	53,452
Residential Suburban	26	4	1%	2,201	1%	50%	1,101
Residential Single Family	647	136	48%	170,477	63%	60%	102,286
Agriculture	1	79	28%	0	0%	0%	-
Total	921	287	100%	270,850	100%	--	190,706
Measured Average Daily Flow (gpd)							190,986
% Difference							0.0%

Table 3-8: Estimated Sewer Flow for FM03

Existing							
Land Use	No. of Sewered Parcels	Area (Ac)	% of Total	Water Usage (gpd)	% of Total	Reduction Factor (%)	Estimated Sewer Flow (gpd)
Commercial Retail	24	29	12%	37,973	17%	90%	34,175
Office and Professional	0	0	0%	0	0%	90%	0
Public Facility	0	0	0%	0	0%	65%	0
Recreation	1	122	52%	86,473	38%	0%	-
Residential Multi-Family	24	2	1%	3,631	2%	90%	3,268
Residential Single Family	454	82	35%	101,986	44%	60%	61,192
Total	503	234	100%	230,063	100%	--	98,635
Measured Average Daily Flow (gpd)							74,332
% Difference							28%

Table 3-9 summarizes future flow estimates under both methods described above.

Table 3-9: Projected Future Sewer Flows (Not including Existing)								
Land Use	No. of Sewered Parcels	Area (Ac)	% of Total	10-Yr Water Production (gpd)	% of Total	Return Factor (%)	Estimated Sewer Flow with Return Factor (gpd)	Estimated Sewer Flow with MP Sewer Factors (gpd)
Commercial Retail	62	71	15%	89,911	21%	90%	80,920	75,810
Commercial Service	11	49	10%	20,663	5%	90%	18,597	12,739
Multi-Land Use Category	0	0	0%	0	0%	90%	0	0
Office and Professional	14	9	2%	5,280	1%	90%	4,752	1,746
Public Facility	2	12	2%	3,916	1%	65%	2,545	5,096
Rural Lands	0	0	0%	0	0%	0%	0	0
Recreation	0	0	0%	0	0%	0%	0	0
Residential Multi-Family	29	38	8%	57,339	13%	90%	51,605	100,939
Residential Suburban	91	132	28%	91,559	21%	50%	45,779	43,542
Residential Single Family	169	153	33%	157,193	37%	60%	94,316	141,490
Agriculture	0	0	0%	0	0%	0%	0	0
Subtotal	378	464	100%	425,861	100%	-	298,515	381,362
Blacklake WRF¹							58,000	58,000
Future ADUs							26,161	26,161
Total Flows							382,676	465,523
Notes:								
1. Blacklake WRF will be decommissioned in the future with flows going to Southland WWTP instead. Future flow from the 2017 Blacklake Sewer Master Plan (MKN) was used.								

Peaking factors for maximum month, peak day, and peak hour flow conditions were determined from historical flows at Southland WWTF between January 2019 and December 2020. Peak hour was determined from data collected between July 2018 and June 2020 for another study being conducted by the District. The following table summarizes these flows and the resulting peaking factors:

Table 3-10: Historical Southland WWTF Influent Flow			
Parameter	Unit	Value	Calculated Peaking Factor (PF)
AAF	MGD	0.50	--
MMF	MGD	0.51	1.02
PDF	MGD	0.57	1.14
PHF	MGD	1.3	2.6

3.1.3. Dana Reserve Wastewater Flow Projections

Approximate wastewater generation from the new development was calculated by the developers in the Dana Reserve Specific Plan totaling an average flow of 0.204 million gallons per day (MGD) and a Peak Hour Flow (assuming a peaking factor of 2.5) of 0.510 MGD. Residential wastewater generation factors were calculated as percentages of the average water demand, with single-family homes above 6000 square feet equaling 60% of the water demand, single-family homes between 4,000 to 6,000 square feet equaling 70%, and 90% for all other residential categories. Wastewater flow generation factors for commercial land uses were derived from the City of San Luis Obispo Infrastructure Renewal Strategy (Dec. 2015).

**Table 3-11: Developer Provided Wastewater Generation Factor and Demand Projections
(Table 5.2 from DRSP Update)**

Land Use Category	Number of Units or Acres	Wastewater Generation Factor ^{3,4} (GPD)	Annual Demand (af/yr)	Daily Demand ² (gpd)
Residential				
Condos	173 units	103/unit	19.93	
Townhomes	210 units	116/unit	27.21	
Cluster	124 units	167/unit	23.21	
4,000-5,999 SF	463 units	130/unit	67.41	
6,000-7,000+ SF	225 units	180/unit	45.36	
Affordable	75 units	116/unit	9.72	
<i>Subtotal</i>			<i>192.84⁵</i>	<i>172,245</i>
Commercial¹				
Village Commercial	4.4 ac	100/k-sf	7.16	
Flex Commercial	14.5 ac	100/k-sf	23.58	
<i>Subtotal</i>			<i>30.74</i>	<i>27,443</i>
Landscape				
Public Recreation	10.0 ac	0.50 af-ft/yr-acre	5.00	
Neighborhood Parks	15.0 ac	-	-	
Streetscape/Parkways	6.5 ac	-	-	
<i>Subtotal</i>			<i>5.00</i>	<i>4,464</i>
<i>Project Total Average Day Flow:</i>			<i>228.68 af/yr</i>	<i>204,152 gpd</i>
<i>Project Peak Flow (assumes 2.5 Peaking Factor):</i>			<i>571.70 af/yr</i>	<i>510,381 gpd</i>
Notes:				
1. Assumes 33% useable site area for buildings.				
2. Conversion factor: 1 af/yr equals 892.742 gpd.				
3. Wastewater flow generation factors for single family are a percentage of average water demand: 60% for 6,000+, 70% for 4,000-6,000, 90% for all others.				
4. Wastewater flow generation factors for commercial: City of San Luis Obispo, Infrastructure Renewal Strategy (Dec. 2015).				
5. Subtotal for Residential land use was identified as 192.94 in the draft table but calculated as 192.84.				
6. Updated Table 5.2 provided in email dated September 23, 2020, from Robert Camacho, RRM Design Group.				

In **Table 3-12**, flows estimated by the developer were compared to estimated wastewater flows developed using both methods (2007 Sewer Master Plan and water usage-based flow estimates) discussed in Section 3.1.2.

Table 3-12: Dana Reserve Wastewater Flow Projections using Water Production-Based and 2007 Sewer Master Plan-Based Methods

Land Use	Acres	10-Year Water Land-Use Factor (GPD/acre)	10-Year Water Production (GPD)	Sewer Flow Return Factor	Sewer Flow Rate Using Water Production and Return Factors (GPD)	2007 Sewer Master Plan Update Duty Factors (GPD/acre)	Sewer Flow Rate Using District Duty Factors (GPD)
Multi-Family Cluster	19.3	2205	42,557	90%	38,301	2,634	50,836
4000 SF Lot	16.2	2205	35,721	90%	32,149	2,634	42,671
4800 SF Lot	53.4	1250	66,750	60%	40,050	924	49,342
6000 SF Lot	26.7	1250	33,375	60%	20,025	924	24,671
6000-7000 SF Lot	15.8	1250	19,750	60%	11,850	924	14,599
Affordable	37.3	1250	46,625	60%	27,975	924	34,465
<i>Subtotal</i>	4	2205	8,820	90%	7,938	2634	10,536
<i>Subtotal</i>	172.7	-	253,598	-	178,288	-	227,120
Flex Commercial	14.5	1326	19,227	90%	17,304	1064	15,428
Village Commercial	4.4	1326	5,834	90%	5,251	1064	4,682
<i>Subtotal</i>	18.9	-	25,061	-	22,555	-	20,110
Public Parks	10	357	3,570	65%	2,321	442	4,420
Neighborhood Parks	15	-	-	-	-	-	-
Streetscapes/park ways	6.5	-	-	-	-	-	-
<i>Subtotal</i>	31.5	-	3,570	-	2,321	<i>Subtotal</i>	4,420
Projected Average Day Flow (Rounded)					203,000		252,000

As shown, the projections provided by the developer closely match the projections using water production and return factors.

The following table summarizes peak flows from Dana Reserve using the peaking factors from **Table 3-10**.

Table 3-13: NCSD Dana Reserve Wastewater Flow Comparison

Projection Method	Average Annual Flow (MGD)	Maximum Month Flow (MGD)	Peak Day Flow (MGD)	Peak Hour Flow (MGD)
Dana Reserve Proposed Peaking Factor	-			2.5 x AAF
Dana Reserve Specific Plan	0.204		--	0.51
Peaking Factor	-	1.02 x AAF	1.14xAAF	2.6 x AAF
2007 Sewer Master Plan Demand Factors	0.251	0.256	0.286	0.653
Water Usage / Return Flows	0.203	0.207	0.231	0.528

The following table summarizes existing District flows, future District projections, future ADU contributions, and Dana Reserve projections. These flows are the basis for evaluating capacity of District facilities and anticipating impact of the Dana Reserve development.

Table 3-14: Existing and Future Flows

Flows	Average Annual Flow (MGD)	Maximum Month Flow (MGD)	Peak Day Flow (MGD)	Peak Hour Flow (MGD)
Existing District and County Service Area Flows	0.59	0.60	0.67	1.5
Future Blacklake Service Area	0.058	0.078	0.13	0.23
Future District Service Area Flows	0.40	0.41	0.46	1.0
ADU Contributions	0.026	0.027	0.030	0.068
Dana Reserve Projections	0.20	0.21	0.23	0.53
Total Future Flows	1.28	1.33	1.53	3.41
Notes:				
1. Blacklake MMF, PDF, and PHF estimated using peaking factors of 1.34, 2.30, and 4.0 respectively from the 2017 Blacklake Sewer Master Plan.				

3.2 Collection System Facilities

3.2.1. Existing Facilities

The District wastewater system consists of ten (10) lift stations in the Town Sewer System, three (3) lift stations in the Blacklake Sewer System, gravity sewer mains, and the Blacklake WRF and Southland WWTF. Treatment facilities are discussed in Section 4 of this study.

As discussed previously in this section, the Blacklake Sewer System will ultimately be connected to the Town Sewer System through a new lift station and force main. In addition to the ten District Town System lift stations, the Town Sewer System receives flow from two County of San Luis Obispo lift stations (Galaxy and People’s Self Help or PSH). Collection system pipeline sizes and lengths for the Town Sewer System are summarized in the table below:

Table 3-15: Existing Sewer Pipeline Statistics		
Diameter (inches)	Length (feet)	% of Total
6	6,038	3.85%
8	116,994	74.67%
10	2,030	1.30%
12	22,713	14.50%
15	3,462	2.21%
18	1,162	0.74%
21	3,152	2.01%
24	1,140	0.73%
Total	157,000 (Rounded)	100%

3.2.2. Proposed Master Plan Facilities

MKN reviewed the District’s 2007 Water and Sewer Master Plan (Master Plan) for proposed improvements that may be necessary to support the development. The completed Frontage Road Trunk Sewer Project implemented Master Plan recommendations between Division Street and Southland WWTF, providing additional capacity downstream of the Dana Reserve Annexation. Of the proposed improvements, the following were identified:

- Replace existing 12-inch with 15-inch between Grande and Division
- Replace existing 10-inch with 15-inch sewer main between Hill Street and Grande Street
- Replace existing 10-inch with 12-inch sewer main between Juniper Street and Hill Street
- Install 8” between Camino Caballo and Juniper Street

3.2.3. Hydraulic Analysis Results and Recommendations

MKN utilized the District’s current SewerCAD hydraulic model to evaluate the impact of the proposed Dana Reserve development on the existing District wastewater collection system based on existing and future projected demands. The focus area was along the Frontage Road trunk sewer, which would convey flow from Dana Reserve to Southland WWTF.

Flow meter data was used to validate existing flow scenarios in the model as described in Section 3.1.1.

For the purpose of this report, scenarios were modeled for both current and future conditions within the District’s Town Sewer System. Model runs were performed under steady state conditions as described below:

- Scenario 1: Existing Average Annual Flow (AADF) conditions
- Scenario 2: Existing Peak Hour Flow (PHF)
- Scenario 3: PHF conditions with Blacklake Sewer Consolidation, future conditions, and Tefft Street lift station (LS) pumped flows
- Scenario 4: PHF conditions with Blacklake Sewer Consolidation, future conditions, Tefft Street LS pumped flows, and Dana Reserve
- Scenario 5: PHF conditions with Blacklake Sewer Consolidation, future conditions, Tefft Street LS pumped flows, Dana Reserve, and Frontage Road improvements per Blacklake Sewer System Consolidation Study

Unless otherwise stated, lift stations were modeled assuming pumped flow is equivalent to inflow. Most of the lift stations pump for only a few minutes every hour, serve small areas or cul-de-sacs, and assuming all pumps were activated at the same time under peak hour conditions resulted in capacity exceedances that were not representative of system observations. In Scenarios 3, 4, and 5, Tefft St Lift Station was modeled to pump at 636 gpm, which is near the design point of 600 gpm at 89.1 ft total dynamic head (TDH).

The scenarios were evaluated based on the following depth over diameter (d/D) criteria, in conjunction with the 2007 Sewer Master Plan Update:

- For pipelines 12-inches or less: $d/D < 50\%$
- For pipelines 15-inches or greater: $d/D < 75\%$

Table 3-16 provides results of the analysis for scenarios listed above on the Frontage Road trunk main. **Figure 3-2** identifies the sewer mains included in the table. The mains that do not meet the d/D criteria are highlighted in red. Under existing conditions, without Tefft Street LS pumped flows, the sewer system meets d/D criteria. However, once Tefft Street pumped flows are included in the analysis, the smaller, upstream mains are too small to meet d/D criteria due to submerged downstream conditions.

Increasing the size of Frontage Road trunk mains beyond sizes recommended in the Master Plan kept d/D within recommended ranges. The following improvements are recommended:

1. Replace existing 10-inch with 3,500 LF 15-inch PVC sewer main and manholes between Juniper Street and Grande Avenue; and
2. Replace existing 12-inch with 1,170 LF 18-inch PVC sewer main and manholes between Grande Avenue and Division Street.

No sewer service is available near the development. The developer will be responsible for installing a lift station with force main, gravity sewer mains, or a combination to connect Dana Reserve to the District sewer system. This decision must be approved by District staff. Installing a lift station to convey all Dana Reserve flows could result in significant impacts to the District sewer system if variable frequency drives are not utilized to reduce instantaneous peak flows from pumps. District staff should revisit the hydraulic analysis for upsizing the existing Frontage Road Trunk sewer after preliminary design for the sewer connection is submitted by the developer.

Table 3-16: Dana Reserve Sewer Model Results

Pipe ID From Sewer Model ¹	Existing Pipe Diameter (in)	Scenario 1: Existing ADF Condition (gpm)	Scenario 1: Existing ADF Condition (d/D)	Scenario 2: Existing PHF Condition (gpm)	Scenario 2: Existing PHF Condition (d/D)	Scenario 3: Future ² PHF with Tefft St LS Pumped Flows (gpm)	Scenario 3: Future ² PHF with Tefft St LS Pumped Flows (d/D)	Scenario 4: Future ² PHF with Tefft St LS Pumped Flows and Dana Reserve (gpm)	Scenario 4: Future ² PHF with Tefft St LS Pumped Flows and Dana Reserve (d/D)	Scenario 5: Future ² PHF with Tefft St LS Pumped Flows, Dana Reserve, and Frontage Rd Improvements ³ (gpm)	Scenario 5: Future ² PHF with Tefft St LS Pumped Flows, Dana Reserve, and Frontage Rd Improvements ³ (d/D)
495(2)	10	24	14.6%	62	23.3%	379	80.6%	746	100.0%	746	49.4%
499	10	24	14.8%	62	23.7%	379	100.0%	746	100.0%	746	50.4%
496	10	24	15.3%	62	24.6%	379	100.0%	746	100.0%	746	52.7%
501	10	24	17.1%	62	29.5%	379	100.0%	746	100.0%	746	56.8%
500	10	24	21.1%	62	36.2%	379	100.0%	746	100.0%	746	58.8%
504	10	60	23.2%	156	38.0%	579	100.0%	946	100.0%	946	56.9%
503	10	63	24.2%	165	39.8%	588	100.0%	955	100.0%	955	59.3%
418	10	63	22.8%	165	37.5%	588	83.1%	955	100.0%	955	56.7%
417	10	66	18.2%	171	29.6%	679	61.9%	1,046	100.0%	1,046	44.2%
446	10	66	17.9%	171	29.0%	679	66.3%	1,046	100.0%	1,046	48.9%
447	10	66	33.3%	171	55.1%	684	83.2%	1,051	100.0%	1,051	69.2%
806	12	131	30.7%	339	50.7%	994	100.0%	1,361	100.0%	1,361	59.3%
807	12	132	30.2%	342	49.2%	997	100.0%	1,364	100.0%	1,364	57.1%
451	12	132	31.6%	344	51.6%	999	100.0%	1,365	100.0%	1,365	59.3%
464	12	134	29.5%	349	49.9%	1,003	100.0%	1,370	100.0%	1,370	58.8%
299	12	134	29.8%	349	50.1%	1,003	82.0%	1,370	87.5%	1,370	57.9%
1010	21	235	15.0%	609	24.2%	1,305	35.9%	1,672	41.0%	1,672	41.0%
1011	21	235	15.1%	609	24.3%	1,305	36.0%	1,672	41.0%	1,672	41.0%
1013	21	238	13.6%	619	21.8%	1,315	32.0%	1,682	36.4%	1,682	36.4%
1014	21	238	16.7%	619	27.2%	1,315	40.2%	1,682	44.7%	1,682	44.7%
1015	21	373	18.7%	968	30.5%	2,075	45.3%	2,442	49.2%	2,442	49.2%
1016	21	384	18.2%	998	29.6%	2,120	43.9%	2,486	47.9%	2,486	47.9%
1020	21	384	18.9%	998	30.8%	2,120	45.5%	2,486	49.5%	2,486	49.5%
1018	21	386	18.5%	1,004	30.0%	2,125	44.5%	2,492	48.6%	2,492	48.6%
1019	21	386	18.5%	1,004	30.1%	2,125	44.6%	2,492	48.7%	2,492	48.7%
1022	21	386	18.5%	1,004	30.0%	2,125	44.5%	2,492	48.6%	2,492	48.6%
1024	21	386	17.2%	1,004	28.2%	2,125	42.1%	2,492	49.6%	2,492	49.6%
1023	21	386	20.2%	1,004	32.8%	2,125	49.5%	2,492	53.9%	2,492	53.9%
1025	24	411	19.3%	1,068	31.2%	2,358	48.0%	2,725	52.3%	2,725	52.3%
1026	24	411	19.4%	1,068	31.4%	2,358	48.4%	2,725	52.7%	2,725	52.7%
1028	24	411	17.8%	1,068	28.9%	2,358	44.0%	2,725	47.7%	2,725	47.7%
1030	24	411	15.1%	1,068	24.4%	2,358	36.6%	2,725	39.5%	2,725	39.5%

Notes:

1. Pipelines are in order from upstream to downstream
2. Future flows include parcels that will tie into the sewer system, potential ADUs developments, and Blacklake pumped flows
3. Frontage Rd pipeline improvements include increasing pipe diameters from 10-inch to 15-inch and from 12-inch to 18-inch



Nipomo Community Services District

Dana Reserve Development - Water and Wastewater Service Evaluation

Figure 3-2
Wastewater Collection System Improvements

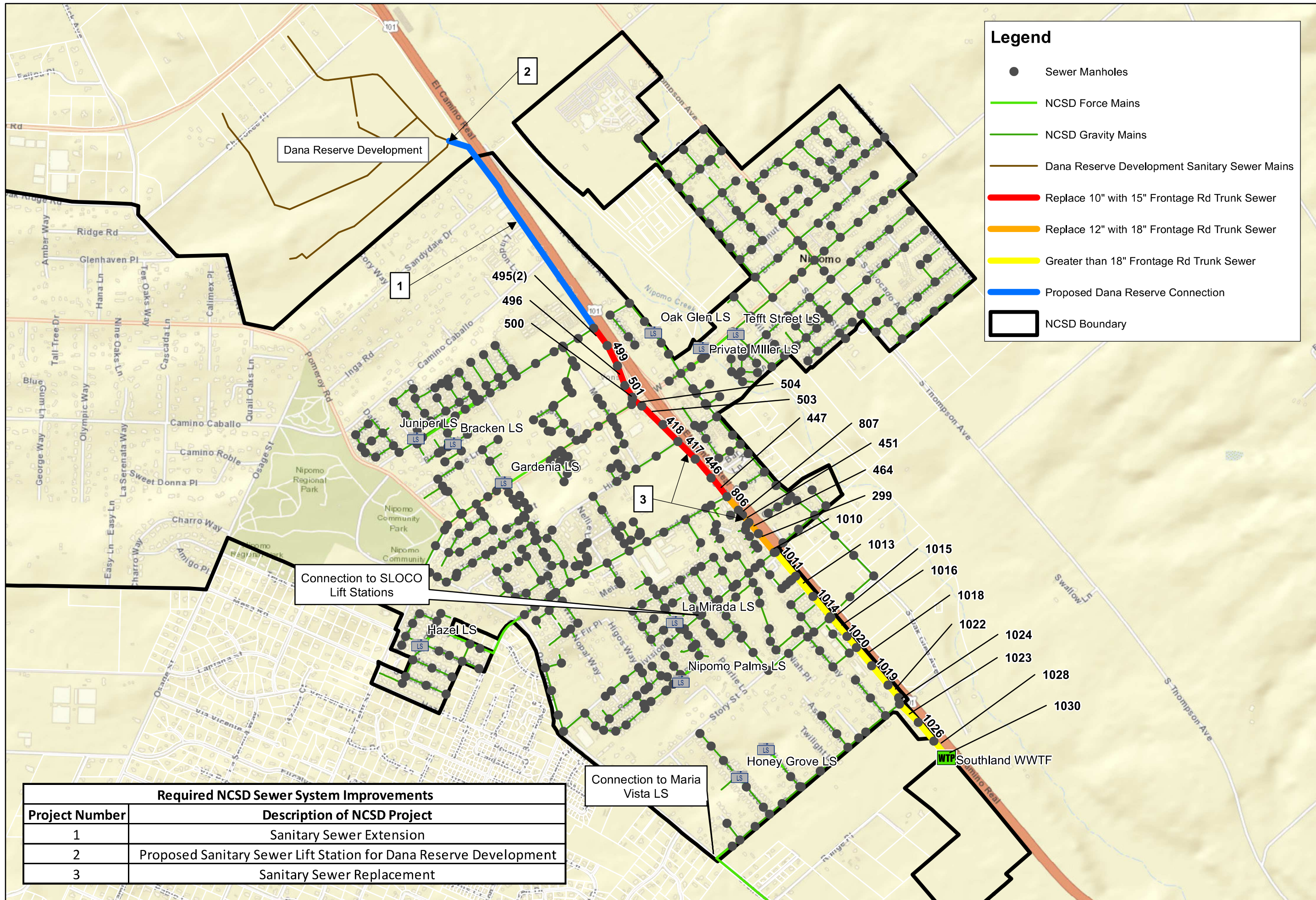

Legend

- Sewer Manholes
- NCS D Force Mains
- NCS D Gravity Mains
- Dana Reserve Development Sanitary Sewer Mains
- Replace 10" with 15" Frontage Rd Trunk Sewer
- Replace 12" with 18" Frontage Rd Trunk Sewer
- Greater than 18" Frontage Rd Trunk Sewer
- Proposed Dana Reserve Connection
- NCS D Boundary

Required NCS D Sewer System Improvements	
Project Number	Description of NCS D Project
1	Sanitary Sewer Extension
2	Proposed Sanitary Sewer Lift Station for Dana Reserve Development
3	Sanitary Sewer Replacement

1 inch = 1,400 feet
0 700 1,400



3.2.4. Recommended Offsite Improvements

The hydraulic analysis indicated that the Dana Reserve development will likely impact the District's wastewater collection system most significantly during PHF conditions. The District should consider implementing the following projects in Frontage Road:

1. Replace existing 10-inch with 3,500 LF 15-inch PVC sewer main and manholes between Juniper Street and Grande Avenue; and
2. Replace existing 12-inch with 1,170 LF 18-inch PVC sewer main and manholes between Grande Avenue and Division Street.
3. The developer will also need to extend sewer service to the Dana Reserve development from Juniper Street.

3.2.5. Evaluation of Proposed Onsite Improvements

The DRSP identifies a network of sewer mains conveying flow to the proposed connection along Frontage Road. Sizes are not identified but it is assumed all mains will be designed and constructed in accordance with District standards. Two lift stations are identified to convey flow from neighborhoods 8 and 9 (near Hetrick Avenue) to the onsite collection system. Not enough information was provided to evaluate capacity of these onsite improvements. It is recommended the developer and District evaluate onsite sewer design and the potential impact of the two lift stations on proposed offsite improvements after preliminary design proceeds.

4.0 WASTEWATER TREATMENT FACILITY

4.1 Influent Flow and Loading Analysis

4.1.1. District Projections

Historical water quality data was analyzed from the Southland WWTF between January 2019 and December 2020. Average annual and maximum monthly flows were calculated as described in Section 3.1.1 and were applied to this water quality data to calculate influent loading values for 5-day biological oxygen demand (BOD₅), total suspended solids (TSS) and Total Kjeldahl Nitrogen (TKN).

Through the Blacklake Sewer Consolidation Project, the Blacklake WRF will be decommissioned and all Blacklake flow will be sent to Southland WWTF as discussed in the previous section. In order to determine whether the Southland WWTF has the capacity to handle the added influent from the proposed Dana Reserve development, the combined existing influent flows and loading rates were analyzed.

As a result of the influent from Blacklake being transmitted through a force main and then being conveyed through a gravity sewer main, the rate of flow from Blacklake will likely be dampened to some extent before reaching the Southland WWTF. As such, using the same peak hour flowrates that were assumed for the Blacklake WRF to estimate the increased inflow to the Southland WWTF is a conservative analysis. Flow values shown in **Table 4-1** are a combination of existing flows to the Southland WWTF and anticipated flows from the Blacklake WRF.

Parameter	Unit	Existing
ADF	MGD	0.65
MMF	MGD	0.68
PHF	MGD	1.76
Average Annual BOD ₅ Concentration	mg/L	403
Average Annual BOD ₅ Load (Rounded)	ppd	2,170
Maximum Month BOD ₅ Concentration	mg/L	537
Maximum Month BOD ₅ Load (Rounded)	ppd	2,890
Average Annual TSS Concentration	mg/L	289
Average Annual TSS Load (Rounded)	ppd	1,560
Maximum Month TSS Concentration	mg/L	333
Maximum Month TSS Load (Rounded)	ppd	1,790

4.1.2. Dana Reserve Projections and Impact on Flows and Loadings at Southland WWTF

The projected flows and loading from the Dana Reserve development are summarized in **Table 4-2**. Since the District’s sewer service area is primarily residential, it is assumed that the BOD and TSS concentrations in the wastewater from the development will be similar to what is currently observed at the Southland WWTF.

Table 4-2: Projected Influent Flows and Loadings from Dana Reserve Project		
Parameter	Unit	Quantity
ADF	MGD	0.204
MMF	MGD	0.210
PHF	MGD	0.533
Average Annual BOD ₅ Concentration	mg/L	403
Average Annual BOD ₅ Load	ppd	686
Maximum Month BOD ₅ Concentration	mg/L	537
Maximum Month BOD ₅ Load	ppd	913
Average Annual TSS Concentration	mg/L	289
Average Annual TSS Load	ppd	492
Maximum Month TSS Concentration	mg/L	333
Maximum Month TSS Load	ppd	566

Flows from Dana Reserve will result in a 31% increase over existing District service area maximum month flows and loads. The projected flows and loads at Southland WWTF including the Dana Reserve Project are summarized in **Table 4-3**.

Table 4-3: Projected Influent Flows and Loadings from Dana Reserve Project and District Service Area		
Parameter	Unit	Existing + Dana Reserve
ADF	MGD	0.85
MMF	MGD	0.89
PHF	MGD	2.30
Average Annual BOD ₅ Concentration	mg/L	403
Average Annual BOD ₅ Load (Rounded)	ppd	2,860
Maximum Monthly BOD ₅ Concentration	mg/L	536
Maximum Monthly BOD ₅ Load (Rounded)	ppd	3,800
Average Annual TSS Concentration	mg/L	289
Average Annual TSS Loading (Rounded)	ppd	2,050
Maximum Monthly TSS Concentration	mg/L	333
Maximum Monthly TSS Loading (Rounded)	ppd	2,360

4.2 Existing Facilities

Wastewater generated in and collected by the District is conveyed to Southland WWTF, a secondary wastewater treatment facility that uses an influent lift station with two (2) screw centrifugal pumps, two (2) fine screens, one (1) grit removal system with classifier, one (1) in-pond extended aeration system (Parkson Biolac®), two (2) secondary clarifiers, 10 percolation ponds. The WWTF also has an existing gravity belt thickener and twelve (12) concrete lined sludge drying beds for waste sludge dewatering. The District recently installed a dewatering screw press to assist in the waste sludge dewatering, particularly during wet weather. A 400 KVA generator provides backup power when needed.

4.3 Proposed Master Plan Facilities

The Southland WWTF site was planned to allow phased improvements as demand increases. The Phase I design included design and construction of the above listed facilities, replacing the previous treatment pond facility to maintain and improve treatment for increasing flows and loading.

Phases II and III were outlined in Southland WWTF Master Plan Amendment 1 (AECOM, 2010) to plan for anticipated increases in flow rate and loading at Southland WWTF. Equipment and processes were designed to be able to meet greater demands with additional equipment, such as additional aeration basins or sludge digesters; in a phased approach without requiring removal or replacement of previous improvements. Anticipated phases and major system components are summarized in the tables below. Planning “triggers”, or flows, at which each phase should be implemented, are also included in **Table 4-4**. At the time the master plan was developed, the 90th percentile BOD₅ and TSS were both 300 mg/L for use in sizing facilities. The existing maximum month TSS is slightly lower (289 mg/L) whereas the BOD₅ is higher (333 mg/L). Therefore, the planning “triggers” should be reconsidered based on actual flows and loadings as compared to the Amendment 1 recommendations.

In the original Amendment 1, the District had planned to construct new aerobic sludge digesters in Phases I and III. However, during the Phase I design, the District opted to install a sludge thickening system instead and twelve (12) sludge drying beds were constructed to store sludge. The aerobic digesters were no longer needed. The sludge handling system was further improved by installing a new dewatering screw press as described above.

Project Phase	Capacity (MMF, MGD)	Planning Trigger (MMF, MGD)
Phase 1 – Existing Facilities	0.9	--
Phase 2	1.28	0.7
Phase 3	1.80	1.4

Phase II included a new pump and associated valves, piping, and controls; aeration system, and blower for Aeration Basin #2; a second clarifier; new concrete liners and decant system in one drying bed; and a new emergency generator. The secondary clarifier, twelve (12) concrete lined drying beds with decant system, and generator were installed as part of Phase I. A third blower was recently installed in the blower building.

Phase III included a second grit removal system and classifier; new Aeration Basin #3 with liner, air piping and headers, controls, and aeration equipment; third clarifier; and new concrete liners and decant system in one drying bed. As noted above, all lined drying beds were installed as part of Phase I. The existing plant is shown on **Figure 4-1**.



Figure 4-1

Southland WWTF

Dana Reserve Development
 Water and Wastewater Service Evaluation
 Nipomo Community Services District

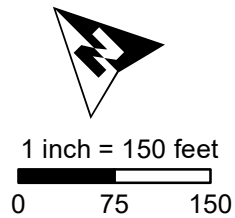

4.4 Process Capacity Analysis

The process flow diagram and design parameters from the Southland WWTF Phase 1 Improvements plans are included as Appendix B. The ability of each process to handle the anticipated combined existing flows and loads was reviewed in the following sub-sections.

4.4.1. Influent Lift Station

The existing influent lift station at the Southland WWTF consists of two screw centrifugal pumps with 20 horsepower motors, and each with a capacity of 1,700 GPM (2.45 MGD) at 30 feet of total dynamic head (TDH). The pumps alternate operation, with one pump operating and the other remaining on standby to provide 100% redundancy.

The existing combined influent PHF is estimated to be 2.30 MGD, which leaves excess capacity of 0.15 MGD while maintaining one pump for standby.

Table 4-5: Influent Lift Station Capacity (One Pump Operating)			
Flow Condition	Units	Design Capacity	Existing + Dana Reserve
Peak Hour Flow	MGD	2.45	2.30
Available Capacity	MGD	-	0.15

With two pumps operating and a third on standby, the estimated capacity is approximately 4.83 MGD as shown in **Table 4-6** below.

Table 4-6: Influent Lift Station Capacity (Two Pump Operating)			
Flow Condition	Units	Design Capacity	Existing + Dana Reserve
Peak Hour Flow	MGD	4.83	2.30
Available Capacity	MGD	-	2.53

The 2012 Conceptual Design Report (CDR) for Southland WWTF identified the future installment of a third pump to handle increased flow in future phases. The wetwell was sized for this anticipated upgrade and piping was installed to accommodate a third similarly-sized pump to handle the increased influent PHF while maintaining one pump in standby mode. The District plans to install a third pump to provide additional redundancy. This will also meet demands from Dana Reserve.

4.4.2. Influent Screens

Southland's existing headworks screen system consists of two shaftless screw screens designed for a peak flow of 4.83 MGD, with a maximum equipment capacity of 5.5 MGD.

With a rated equipment capacity of 5.5 MGD each, the headworks screens have the ability to handle anticipated combined existing and future peak hour flow rates.

4.4.3. Grit Removal

Southland WWTF's existing grit removal system consists of one vortex-type grit tank with a single self-priming grit pump. One grit tank was installed during the Phase I Improvements, with provisions to add a second in the future.

The grit tank was designed for a peak flow of 2.5 MGD. The combined existing influent PHF with Dana Reserve is estimated to be 2.30 MGD. Since existing flows with Dana Reserve will nearly meet capacity without redundancy, a second grit removal system is recommended. With the second grit removal system installed, the design capacity of 5.0 MGD will provide an estimated 2.7 MGD of additional capacity.

4.4.4. Extended Aeration System

Southland WWTF currently operates one extended aeration basin with a total volume of 1.41 million gallons (MG) and a design mixed liquor suspended solids (MLSS) concentration of 3,223 mg/L. The existing basin was designed for a solid retention time (SRT) of 60 to 70 days and a hydraulic retention time (HRT) of 1.63 days. The basin was sized based on a recommended range of BOD₅ loading to the aeration basin of 5 to 12 ppd per 1000 cubic feet of basin volume. The combined loads are compared with the design minimum and maximum capacity in the table below.

Condition	Units	Recommended Design Criteria (Min – Max)³	Existing + Dana Reserve
Average Annual BOD ₅ Load	ppd	943 – 2,262	2,860
Maximum Month BOD ₅ Load	ppd	943 – 2,262	3,800

The existing maximum month BOD₅ load with Dana Reserve exceeds the maximum design criteria by 1,538 ppd, indicating that a second aeration basin will be needed. In addition to the aeration basin, new diffusers, and supporting electrical, mechanical, and instrumentation will be required. A new blower, new blower building or expansion of the existing blower building will be necessary if aeration is not sufficient to meet projected demands.

4.4.5. Secondary Clarifiers

Two existing 55-foot diameter concrete circular secondary clarifiers are operating at Southland WWTF, each with a design overflow rate (OFR) of 240 gallons per day per square foot (gpd/ft²) at ADF and 694 gpd/ft² at PHF. Industry standards⁴ recommend overflow rates of 200 – 400 gpd/ft² for average flow conditions and 600 – 800 gpd/ft² at peak flow conditions. Each clarifier is designed for a solids loading of 0.95 pounds per square foot per hour (lbs/ft²/hr) at average conditions and 1.67 lbs/ft²/hr at peak conditions. The design overflow rates and solids loading rates are compared with the anticipated existing combined flow and loading conditions in **Table 4-8**.

³ Min = 5 ppd/1000 cf of basin volume. Max = 12 ppd/1000 cf of basin volume.

⁴ Wastewater Engineering Treatment & Reuse, 4th Edition, Tchbanoglous, et. al.

Table 4-8: Secondary Clarifier Existing Capacity

	Average Overflow Rate	Peak Overflow Rate	Average Solids Loading Rate	Peak Solids Loading Rate
Units	gpd/ft ²	gpd/ft ²	lb/ft ² /hr	lb/ft ² /hr
Design Value	240	694	0.95	1.67
Recommended Range	200 - 400	600 - 800	0.2 - 1.0	<1.4
1 Clarifier	358	967	1.00	2.71
2 Clarifiers	179	483	0.50	1.35

With one clarifier operating, the existing combined average OFR falls well within the recommended range outlined by Tchbanoglous, et al. (ibid.) However, the combined peak OFR exceeds the recommended maximum value by 167 gpd/ft² and the peak solids loading rate exceeds the maximum value by 1.31 lb/ft²/hr.

With two clarifiers operating, both the existing combined average OFR and the peak OFR fall under the lower bound of the recommended range. However, this is not anticipated to be an issue as the District is successfully operating two clarifiers under existing conditions. The existing average solids loading rate falls within the recommended range for one clarifier and the peak solids loading rate is less than the maximum with two operating clarifiers. However, this leaves no redundancy in the event one clarifier is out of service. Therefore, a third clarifier is recommended to meet existing conditions with Dana Reserve’s contribution.

The existing clarifiers have Return Activated Sludge (RAS) pump stations, consisting of two pumps, each with a capacity of 875 GPM. The Phase I Concept Design Report (CDR – AECOM, 2015) assumed RAS flowrates at 150% of the AAF and designed the RAS pumps to meet 150% of 0.84 MGD (approximately 1.2 MGD). The existing combined AAF is anticipated to be 0.85 MGD which is greater than the design range of the pumps. District staff can operate RAS pumps closer to 100% of AAF. However, it is recommended to upgrade RAS pumps to provide flexibility under increased flows from Dana.

4.4.6. Sludge Thickener

Southland WWTF currently conveys between 34,000 and 51,000 gallons of sludge per day to the existing gravity belt thickener. The waste sludge has a solids concentration between 0.35 and 0.5 percent total solids. The gravity belt thickener currently operates between 6 and 7 hours per day for approximately 35 hours per week. The annexation and Blacklake consolidation will increase the average annual flow, organic loads, and solids loads at the Southland WWTF by 44 percent, which will have a significant impact on the run time for the thickener. It is assumed sludge feed rates under the combined existing and Dana Reserve loading scenario will increase as a percentage based on average annual loading. This methodology yields an estimated sludge waste rate between 49,000 and 74,000 gallons per day for existing combined load conditions. It is anticipated that the sludge thickener may need to run for an additional 16 hours per week, between 9 and 11 hours per day, for a total of approximately 51 hours per week. This would require plant staff to work an additional two days per week to operate and observe the gravity belt thickener. An additional thickener is recommended for redundancy.

4.4.7. Sludge Dewatering Screw Press and Sludge Drying Beds

The District is completing installation of a new sludge dewatering screw press at the Southland WWTF. The sludge dewatering screw press will have a hydraulic capacity of 15 to 90 GPM and a solids capacity of 250 pounds per

hour (PPH). The design feed concentration ranges from 0.5% to 3% total solids and the dewatered sludge concentration is a minimum of 15% total solids. During normal operation, the screw press will receive thickened sludge from the gravity belt thickener, and, thus, will operate for the same durations as the thickener. Two days of operation will be added to accommodate Dana Reserve loads. A second press is recommended for redundancy.

In the event a screw press is taken out of service, the District has sludge drying beds that are utilized to store dewatered sludge. They can be used to temporarily store thickened sludge in case a screw press is out of service. The remaining screw press can also be operated for longer periods during the day to accommodate a short-term outage.

4.5 Future Water Quality Requirements

The Central Coast Regional Water Quality Control Board (RWQCB) recently adopted General Waste Discharge requirements for Discharges from Domestic Wastewater Systems with Flows Greater than 100,000 gallons per day (Order No. R3-2020-0020). RWQCB staff have indicated that the Southland WWTF will likely be enrolled under this General Order. However, the schedule for this is not known. The General Order contains stricter effluent limits, including a total nitrogen limit of 10 mg/L and varying limits for salts, depending on the underlying groundwater basin. The General Order includes a provision allowing 24 months to come into compliance for dischargers that are unable to meet the effluent requirements after enrollment under the Order. Additional time may be granted through a request for a time schedule order. The effluent limits anticipated for Southland WWTF under this General Order are summarized in the table below.

Table 4-9: General Order R3-2020-0020 Secondary Treatment Effluent Limits (Tables 5 and 6 of the Order)

Constituent	Units	30-day Average	7-day Average	Sample Maximum
BOD ₅	mg/L	30	45	NA
TSS	mg/L	30	45	NA
Settleable Solids	mg/L	0.1	0.3	0.5
pH	NA	6.5 – 8.4	NA	NA
Limits based on a 25-month rolling median, for the Lower Nipomo Mesa SubBasin (1)				
Total Nitrogen	mg/L	10	--	--
Total Dissolved Solids (TDS)	mg/L	710	--	--
Chloride	mg/L	95	--	--
Sulfate	mg/L	250	--	--
Boron	mg/L	0.16	--	--
Sodium	mg/L	90	--	--
Notes:				
1. The General Order indicates dischargers have two options for meeting requirements for Total Nitrogen, TDS and the other salt constituents. The discharger may comply with the effluent limitations specified, or the discharger will be required to implement a groundwater monitoring program to demonstrate compliance.				

Increasing use of Supplemental Water is anticipated to reduce discharge of TDS, chloride, and sodium from the WWTF. MKN reviewed historical effluent water quality to evaluate the existing WWTF performance regarding nitrogen reduction and ability to meet the future total nitrogen limit.

Total nitrogen in wastewater includes ammonia, nitrate, nitrite, and organic nitrogen. The Southland WWTF utilizes the Parkson Biolac® system, which when operated in the wave oxidation mode, has the ability to both nitrify (convert ammonia to nitrate) and denitrify (convert nitrate to nitrite and nitrogen gas). This will require operating the extended aeration basins at loading rates of 5 to 9 lb BOD₅/1000 cubic feet (cf), instead of the range of 5 to 12 lb BOD₅/1000 cf recommended for organics removal to meet current effluent limits.

The following table summarizes the anticipated loading of a two-basin system and the design criteria to meet this effluent nitrogen limit under current combined loading rates.

Table 4-10: Extended Aeration Basin Capacity for Denitrification via Wave Oxidation (Two Basins)

Condition	Units	System Design Criteria	Existing + Dana Reserve
Average Annual BOD ₅ Load	lb/day	1,886 – 3,394	2,860
Maximum Month BOD ₅ Load	lb/day	1,886 – 3,394	3,800

As shown, a two-basin system meets the design criteria for denitrification under existing combined average annual loading but not under maximum month loading conditions.

A three-basin system was then evaluated and it was found that the capacity exceeds the requirements under each loading condition. The results of this analysis are shown in the table below.

Flow Condition	Units	Minimum System Design Criteria	Existing + Dana Reserve
Average Annual BOD5 Load	lb/day	2,829-5,091	2,860
Maximum Monthly BOD5 Load	lb/day	2,829-5,092	3,800

In summary, Aeration Basins #2 and #3 will be necessary to meet future permit requirements under existing conditions with Dana Reserve. In addition to the aeration basins, new diffusers, and supporting electrical, mechanical, and instrumentation will be required. A new blower building or expansion of the existing blower building will also be necessary.

4.6 Recommended Improvements

The following table summarizes the capacity assessment described in the previous sections.

Process	Summary of Findings	Recommendations to Meet Existing Demands with Dana Reserve
Influent Lift Station	Capacity is adequate for existing conditions.	Install a third pump, sized the same as existing
Influent Screen	Capacity is adequate for existing flowrates	-
Grit Removal	Capacity is adequate for existing conditions.	Install second grit system
Extended Aeration Basins	Additional basins required	Install Aeration Basin #2 to meet current capacity requirements. Install Aeration Basin #3 to meet anticipated permit requirements. Expand blower system as needed
Secondary Clarifiers	Overflow rate is adequate for existing conditions. Peak solids loading rate is exceeded at existing demands with Dana Reserve.	Install third clarifier for redundancy. Upgrade RAS pumping system.
Gravity Belt Thickener (GBT)	Additional operating hours will be necessary to meet existing demands with Dana Reserve. No redundancy is available if the single GBT fails.	Install second GBT
Dewatering Screw Press	Additional press required to meet combined loading.	Install second screw press

5.0 PROJECT COST OPINIONS

Appendix C includes assumptions and calculations used to develop conceptual project cost opinions. The opinions of probable project costs presented in this study were developed according to the ACE International Class 4 level cost estimate classification. The cost opinions incorporate the engineer’s judgment as a design professional, are planning level budget estimates, and are supplied for the general guidance of the District.

Since MKN has no control over the cost of labor and materials, MKN does not guarantee the accuracy of such opinions as compared to contractor bids or actual cost to the District. It is recommended that an opinion of cost be developed and updated during project design. A construction contingency of 30% and allowance for engineering, construction management, and administration of 30% were applied to construction cost subtotals. All cost opinions were developed in September 2021 (ENR-LA = 13212.48).

5.1 Offsite Water Improvements

The following table summarizes project costs to connect the Dana Reserve water system as described in Section 3. Projects are identified on Figure 6-1. Costs for the developer to extend the waterline to the existing connection along Frontage Road are not included below.

Table 5-1: Water Transmission Main to Serve Dana Reserve		
Project	Description	Cost
1,2,5	New 16” Main on North Oak Glen Drive and Tefft Street	\$10,510,000
Total		\$10,510,000

Table 5-2 summarizes project costs for the end-of-line (EOL) looping at Willow Road and storage improvements at the Foothill Tank and Joshua Road sites.

Table 5-2: Water System Storage and Looping Improvements to Serve Dana Reserve		
Project Number	Description	Cost
4	Willow Road EOL Project	\$260,000
6	Foothill Tank Improvements	\$3,920,000
7	Joshua Road Reservoir	\$4,760,000
Total		\$8,940,000

5.2 Offsite Wastewater Collection and Treatment Improvements

The following table summarizes project costs to connect the Dana Reserve wastewater system as described in Sections 3 and 4. Costs for the developer to connect to the existing system are not included below.

Table 5-3: Wastewater Improvements to Serve Existing Conditions and Dana Reserve		
Project	Description	Cost
3	Wastewater Collection Improvements	\$3,630,000
4 – 9	Southland WWTF Improvements	\$15,960,000
Total		\$19,590,000

6.0 CONCLUSIONS AND RECOMMENDATIONS

6.1 Water

The Dana Reserve Development will have a significant impact on District water and wastewater facilities. Groundwater and 2025 NSWP allocation are adequate to serve existing and future demands with Dana Reserve. However, pipeline and storage improvements will be needed. Figures 6-1 and 6-2 identify the projects described below.

Installing the Willow Road EOL Connection will address the District's looping requirements. Implementing the following project is recommended to convey NSWP water to Dana Reserve:

- Construction of new 16-inch pipeline on North Oak Glen Drive from Tefft Street to the Sandydale connection point.
- Replacement of the existing 10-inch AC pipeline from the Foothill Tanks to North Oak Glen Drive on Tefft Street with a new 16-inch PVC pipeline.

Storage improvements are also recommended to manage additional flow from NSWP and to meet emergency, fire flow, and operational needs. The recommended improvements for Foothill Tank site include a new 1.0 MG storage tank, chloramination improvements, and an automated valve station to improve storage and protect water quality. A new 500,000 gallon reservoir at Joshua Road Pump Station should be constructed to provide operational redundancy for NSWP.

The following table summarizes the recommended improvements

Table 6-1: Recommendations for NCS D Water System Improvements	
Project	Required Improvements
1, 2, 5	New 16" Main on North Oak Glen Drive and Tefft Street
3	Frontage Road Waterline Extension
4	Willow Road EOL Project
6	Foothill Tank Improvements
7	Joshua Road Reservoir

6.2 Wastewater

A new sewer connection from the development to Juniper Street is required which may involve a lift station and force main with sections of gravity sewer. Lift station peak flows should be managed with the use of variable frequency drives to reduce impact to receiving sewers. Improvements along Frontage Road will also be necessary to accommodate flow from the development under existing District demands. These project improvements are listed below and identified in Figures 6-3 and 6-4:

Table 6-2: Recommendations for NCSO Sewer System Improvements	
Project	Required Improvements
1	Connection to Dana Reserve collection area.
2	Potential sanitary sewer lift station for Dana Reserve Development
3	Replace existing 10-inch with 3,500 LF of 15-inch PVC sewer main and manholes between Juniper Street and Grande Avenue.
	Replace existing 12-inch with 1,170 LF 18-inch PVC sewer main and manholes between Grande Avenue and Division Street.

Southland WWTF will require significant improvements to meet existing demands with Dana Reserve and future demands. The table below summarizes improvements necessary to meet current Waste Discharge Requirements.

Table 6-3: Recommendations for Southland WWTF Improvements		
Project	Process	Required Improvement
4	Influent Lift Station	Install a third pump, sized the same as existing
5	Grit Removal	Install second grit system
6	Extended Aeration Basins	Install Aeration Basins #2 & #3 and expand aeration system
7	Secondary Clarifiers	Install third clarifier for redundancy. Upgrade RAS pumping system.
8	Gravity Belt Thickener (GBT)	Install second GBT
9	Dewatering Screw Press	Install second screw press

In addition to the aeration basins, new diffusers and supporting electrical, mechanical, and instrumentation will be required. A new blower building or expansion of the existing blower building will also be necessary.



Nipomo Community Services District

Dana Reserve Development - Water and Wastewater Service Evaluation

Figure 6-1
Proposed Water Distribution System Improvements



1 inch = 1,500 feet

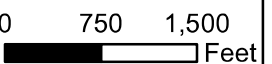

Required NCS D Water System Improvements	
Project Number	Description of NCS D Project
1	Waterline Extension - 16 inch DIP
2	Waterline Crossing Under 101 - 16 inch DIP
3	Waterline Extension - 12 inch PVC
4	Waterline Extension - 12 inch PVC
5	Waterline Replacement - Replace 10 inch with 16 inch DIP
6	Foothill Tank #5/#6

Legend

- NCS D Boundary
- Dana Reserve Development
- Dana Reserve Development Water Mains
- Proposed 16" on N Oak Glen Ave and Tefft St from Foothill Tanks
- Proposed 12" Loop on Willow Rd
- Existing Water Distribution System
- Tank

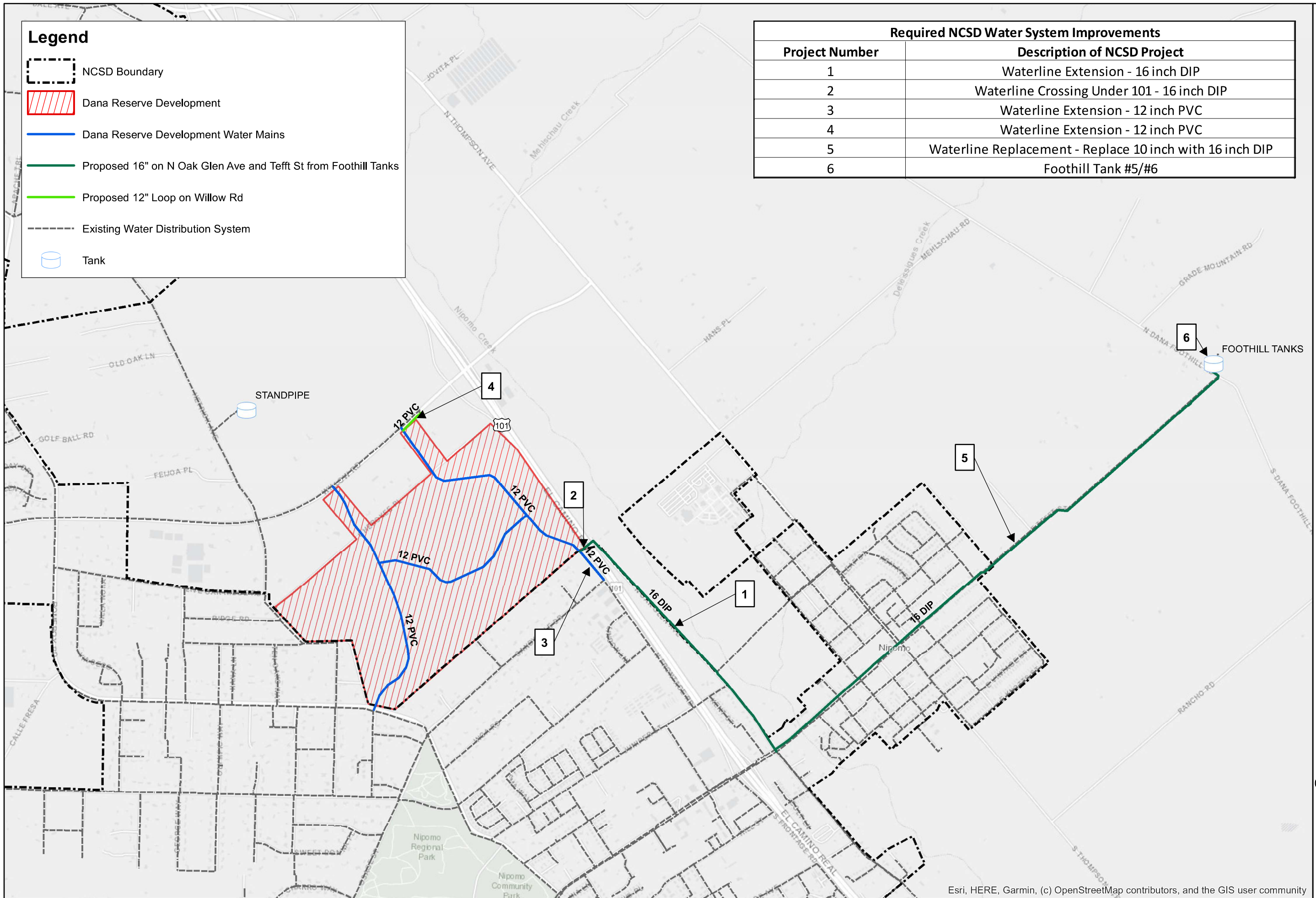



Nipomo Community Services District

Dana Reserve Development - Water and Wastewater Service Evaluation

Figure 6-2
Proposed Joshua Road Pump Station Reservoir Improvements

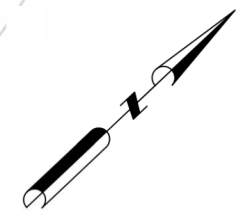
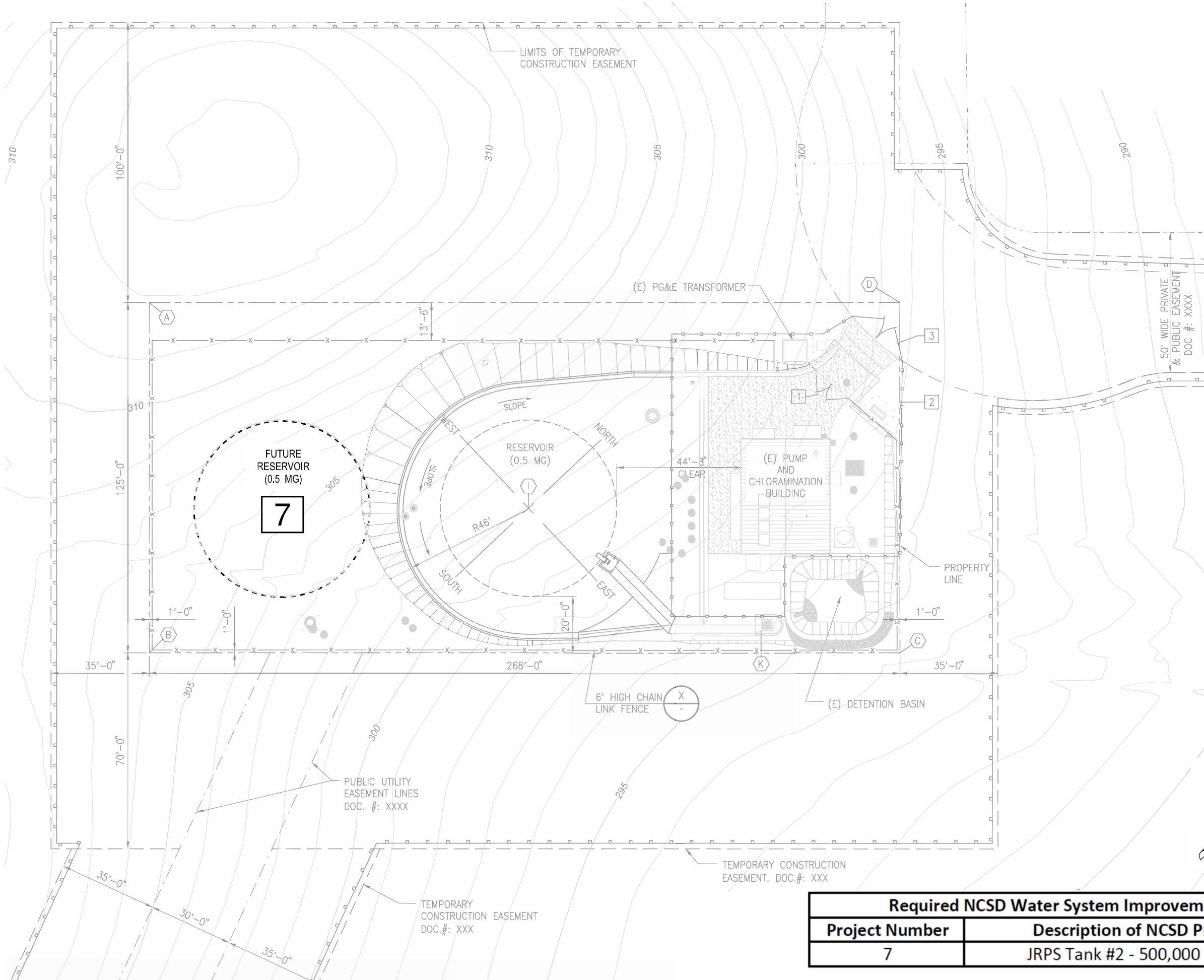

NTS
[Scale bar]

Required NCSD Water System Improvements	
Project Number	Description of NCSD Project
7	JRPS Tank #2 - 500,000 Gallon





Nipomo Community Services District

Dana Reserve Development - Water and Wastewater Service Evaluation

Figure 6-3 Wastewater Collection System Improvements

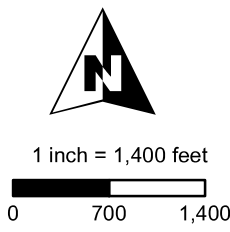
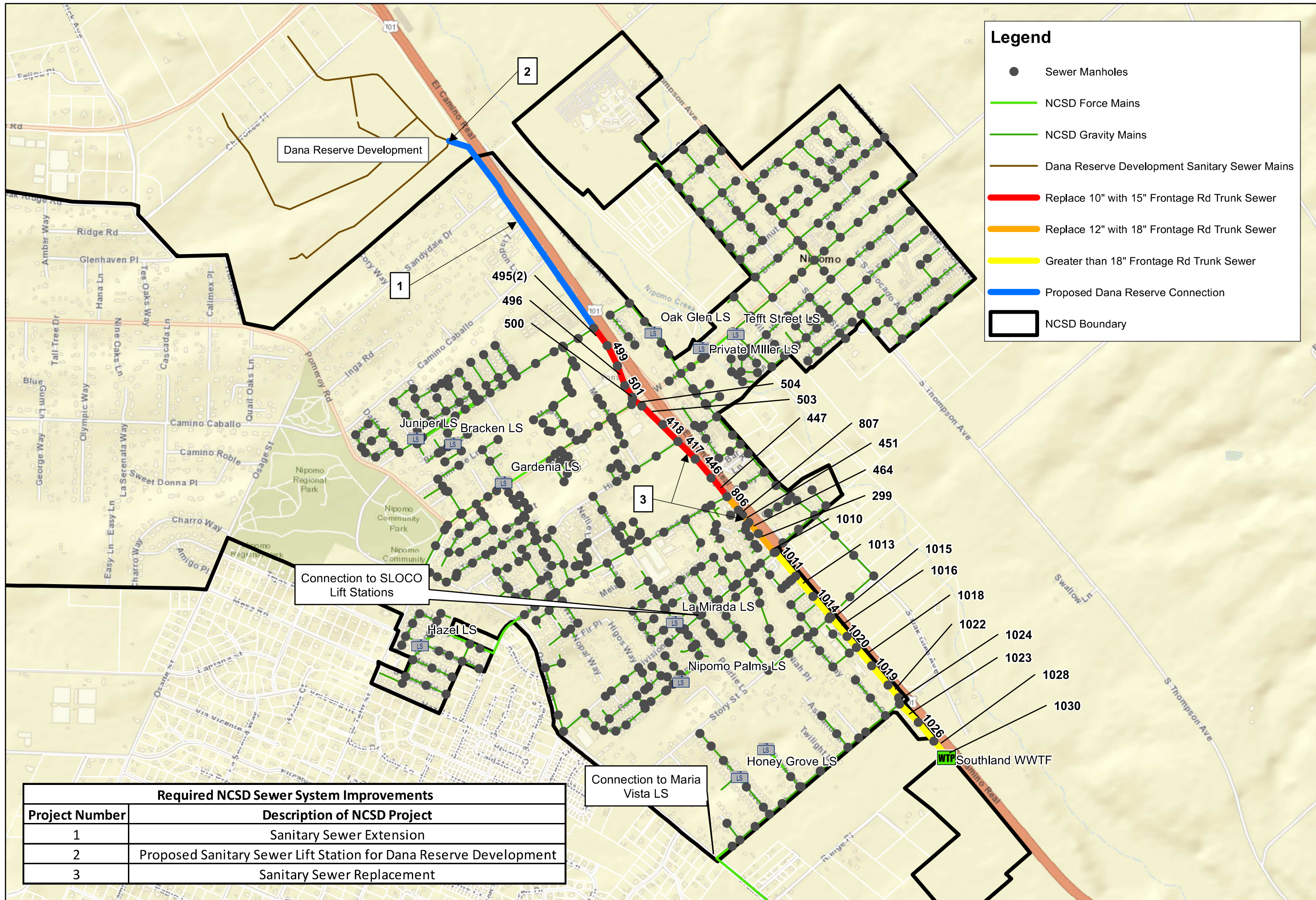

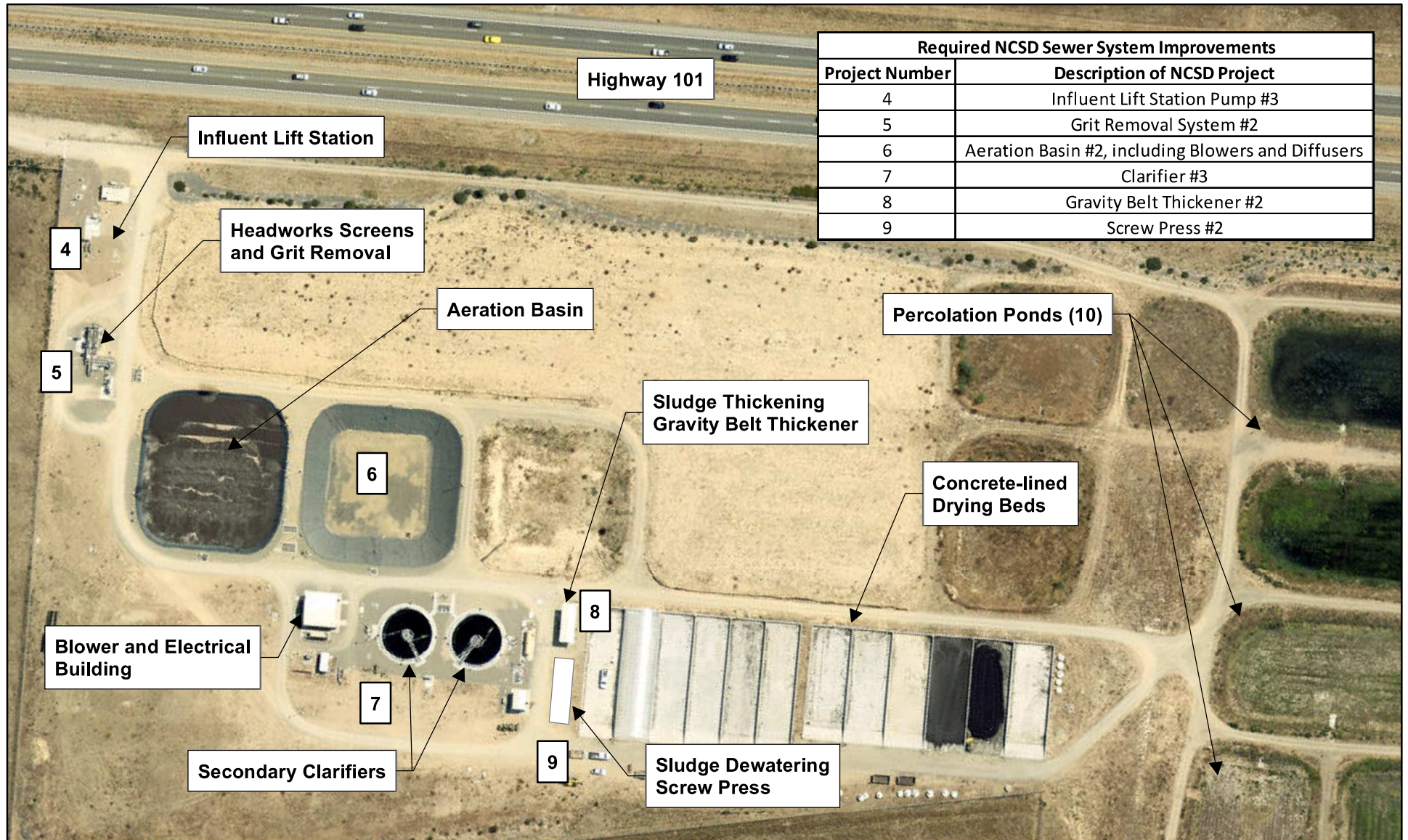
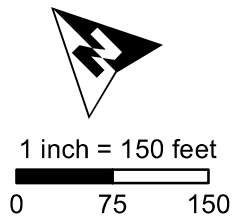

Figure 6-4
 Proposed Southland WWTF Improvements
 Dana Reserve Development
 Water and Wastewater Service Evaluation
 Nipomo Community Services District



APPENDIX A

Sewer Flow Monitoring 2020 Nipomo, CA

October 23, 2020 – November 28, 2020

Final Report Submitted to **MKN & Associates, Inc.**
December 22, 2020



ADS ENVIRONMENTAL
SERVICES

15201 Springdale Street
Huntington Beach, CA 92649

800-633-7246
www.adsenv.com



December 22, 2020

Rob Lepore, GISP
Michael K. Nunley & Associates, Inc.
P.O. Box 1604
Arroyo Grande, CA 93421

SUBJECT: Sewer Flow Monitoring 2020, Nipomo, CA Final Report

Dear Mr. Lepore,

ADS is pleased to submit the report for the Nipomo, CA Sewer Flow Monitoring Study completed on behalf of MKN & Associates, Inc. The metering was conducted at three (3) locations. The study was conducted during the period of Friday, October 23, 2020 to Saturday, November 28, 2020.

The report contains depth, velocity, and quantity hydrographs as well as daily long tables for the metering period. An Excel file containing depth, quantity, and velocity entities for the monitoring location in 5-minute format was provided previously.

In addition, we would be happy to further explain any details about the report that may seem unclear. Should you have any questions or comments, you may contact the Project Manager, Paul Mitchell at 714-379.9778.

It has been our pleasure to be of service to you in the performance of this project. Thank you for choosing ADS products and services to meet your flow monitoring needs.

Sincerely,

ADS ENVIRONMENTAL SERVICES

Jackie Crutcher
Data Manager

ADS LLC

An IDEX Fluid & Metering Business

Accusonic

ADS Environmental

Services Hydra-Stop



Sewer Flow Monitoring 2020 Nipomo, CA

Prepared For:



Rob Lepore, GISP
Michael K. Nunley & Associates, Inc.
P.O. Box 1604
Arroya Grande, CA 93421
p: 805.904.6530 Ext 104 m: 805.748.2106
w:mknassociates.us e:rlepore@mknassociates.us

Prepared By:



ADS, LLC
15201 Springdale Street
Huntington Beach, CA 92649

Table of Contents

Scope & Methodology.....	1
FM01altB	5
Site Commentary	5
Site Report	7
Hydrograph Report.....	8
Scattergraph Report.....	9
Daily Tabular Report	10
FM02.....	11
Site Commentary	11
Site Report	13
Hydrograph Report.....	14
Scattergraph Report.....	15
Daily Tabular Report	16
FM03.....	17
Site Commentary	17
Site Report	19
Hydrograph Report.....	20
Scattergraph Report.....	21
Daily Tabular Report	22

Scope and Methodology

Introduction

Michael K. Nunley & Associates, Inc. ([mkn](#)) entered into an agreement with ADS Environmental Services to conduct flow monitoring at (3) three locations in the Nipomo, CA Sanitary Collection System. The study was scheduled for a period of (30) thirty calendar days. Seven additional data days have been provided. Once in place, the flow monitoring equipment was used to measure depth, velocity, and to quantify flows. The objective of this study was to confirm sanitary sewer flows in the monitored locations for planning purposes.

Project Scope

The scope of this study involved using flow monitors to quantify wastewater flow at the designated locations for the 37-day time period. Specifically, the study included the following key components.

- Investigate the proposed flow-monitoring site for adequate hydraulic conditions
- Flow monitor installation
- Flow monitor confirmations and data collections
- Flow data analysis

The monitoring period began on October 23, 2020 and was completed on November 28, 2020. Equipment was removed from the system on December 09, 2020.

Flow Monitoring Equipment



The **ADS FlowShark Triton** monitor was selected for this project. This flow monitor is an area velocity flow monitor that uses both the Continuity and Manning's equations to measure flow.

The ADS FlowShark Triton monitor consists of data acquisition sensors and a battery-powered microcomputer. The microcomputer includes a processor unit, data storage, and an on-board clock to control and synchronize the sensor recordings. The monitor was programmed to acquire and store depth of flow and velocity readings at 5-minute intervals.

The FS Triton monitor features cross-checking using multiple technologies in each sensor for continuous running of comparisons and tolerances. The FS Triton monitor can support two (2) sets of sensors. The sensor option used for this project was:

The Peak Combo Sensor installed at the bottom of the pipe includes three types of data acquisition technologies.

The **up looking ultrasonic depth** uses sound waves from two independent transceivers to measure the distance from the sensor upward toward the flow surface; applying the speed of sound in the water and the temperature measured by sensor to calculate depth.

The **pressure depth** is calculated by using a piezo-resistive crystal to determine the difference between hydrostatic and atmospheric pressure. The pressure sensor is temperature compensated and vented to the atmosphere through a desiccant filled breather tube.

To obtain **peak velocity**, the sensor sends an ultrasonic signal at an angle upward through the widest cross-section of the oncoming flow. The signal is reflected by suspended particles, air bubbles, or organic matter with a frequency shift proportional to the velocity of the reflecting objects. The reflected signal is received by the sensor and processed using digital spectrum analysis to determine the peak flow velocity.

Installation

Installation of flow monitoring equipment typically proceeds in four steps. First, the site is investigated for safety and to determine physical and hydraulic suitability for the flow monitoring equipment. Second, the equipment is physically installed at the selected location. Third, the monitor is tested to assure proper operation of the velocity and depth of flow sensors and verify that the monitor clock is operational and synchronized to the master computer clock. Fourth, the depth and velocity sensors are confirmed and line confirmations are performed.

In pipes up to 42 inches in diameter, the sensors were mounted on expandable stainless-steel rings, inserted at least a foot upstream into influent pipes and tightened against the inside walls of the pipes. Influent pipe installations reduce the influences of turbulence and backwater often caused by changes in channel geometry in manholes.





Data Collection, Confirmation, and Quality Assurance

Data collects were done remotely via wireless connect on a weekly basis. As needed, during the monitoring period, field crews visit each monitoring location to verify proper monitor operation and document field conditions. The following quality assurance steps are taken to assure the integrity of the collected data:

Measure power supplies: monitors were powered by dry cell battery packs. Voltages were recorded and battery packs replaced, as necessary. Separate batteries provided back-up power to memory allowing primary batteries to be replaced without loss of data.

Clock synchronization: Field crews synchronized monitor clocks to master clocks.

Confirm depth and velocity readings: Field crews descended into meter manholes to manually measure depths and velocities and compare them meter readings to confirm that they agreed. They also measured silt levels, if any, in the inverts of the pipes. Silt areas were subtracted from flow areas to compute true areas of flow.

Confirm average velocities through cross-sectional velocity profiles: Since ADS velocity sensors measure peak velocity, field crews collected cross-sectional velocity profiles in order to develop a relationship between peak and average velocity in lines that meet the hydraulic criteria.

Upload and Review Data: Data collected from the monitors were uploaded and reviewed by a Data Analyst for completeness, outliers and deviations in the flow patterns, which indicate system anomalies or equipment failure.

Flow Quantification Methods

There are two main equations used to measure open channel flow: the **Continuity Equation** and the **Manning Equation**. The Continuity Equation, which is considered the most accurate, can be used if both depth of flow and velocity are available. In cases where velocity measurements are not available or not practical to obtain, the Manning Equation can be used to estimate velocity from the depth data based on certain physical characteristics of the pipe (i.e. the slope and roughness of the pipe being measured). However, the Manning equation assumes uniform, steady flow hydraulic conditions with non-varying roughness, which are typically invalid assumptions in most sanitary sewers. The Continuity Equation was used exclusively for this study.

Continuity Equation

The Continuity Equation states that the flow quantity (Q) is equal to the wetted area (A) multiplied by the average velocity (V) of the flow.

$$Q = A * V$$

This equation is applicable in a variety of conditions including backwater, surcharge, and reverse flow.

Data Analysis and Presentation

Data Analysis

A flow monitor is typically programmed to collect data at 5-minute intervals throughout the monitoring period. The monitor stores raw data consisting of (1) the ultrasonic depth, (2) the peak velocity and (3) the pressure depth. The data is imported into ADS's proprietary software and is examined by a data analyst to verify its integrity. The data analyst also reviews the daily field reports and site visit records to identify conditions that would affect the collected data.

Velocity profiles and the line confirmation data developed by the field personnel are reviewed by the data analyst to identify inconsistencies and verify data integrity. Velocity profiles are reviewed and an average to peak velocity ratio is calculated for the site. This ratio is used in converting the peak velocity measured by the sensor to the average velocity used in the Continuity equation. The data analyst selects which depth sensor entity will be used to calculate the final depth information. Silt levels present at each site visit are reviewed and representative silt levels established.

Occasionally the velocity sensor's performance may be compromised resulting in invalid readings sporadically during the monitoring period. This is generally caused by excessive debris (silt) blocking the sensor's crystals, shallow flows (~< 1") that may drop below the top of the sensor or very clear flows lacking the particles needed to measure rate. In order to use the Continuity equation to quantify the flow during these periods, a Data Analyst and/or Engineer will use the site's historical pipe curve (depth vs. velocity) data along with valid field confirmations to reconstitute and replace the false velocity recordings with expected velocity readings for a given historical depth along the curve.

Selections for the above parameters can be constant or can change during the monitoring period. While the data analysis process is described in a linear manner, it often requires an iterative approach to accurately complete.

Data Presentation

This type of flow monitoring project generates a large volume of data. To facilitate review of the data, results have been provided in graphical and tabular formats. The flow data is presented graphically in the form of scattergraphs and hydrographs. Hydrographs are based on 5-minute averaging. Tables are provided in daily average format. These tables show the flow rate for each day, along with the daily minimum and maximums, the times they were observed, the total daily flow, and total flow for the month (or monitoring period). The following explanation of terms may aid in interpretation of the flow data table and hydrograph.

DEPTH - Final calculated depth measurement (in inches)

QUANTITY - Final calculated flow rate (in MGD)

VELOCITY - Final calculated flow velocity (in feet per second)

REPORT TOTAL - Total volume of flow recorded for the indicated time period (in MG)

FM01altB

Site Commentary

SITE INFORMATION

Pipe	Round (23.38 in H)
Silt	0.00 (in)

OVERVIEW

FM01altB functioned under normal conditions during the period Friday, October 23, 2020 to Saturday, November 28, 2020. The flow pattern at this site exhibits frequent changes in both depth and velocity throughout the day. The saw-toothed like pattern indicates the influence of pump station activity. Review of the Scattergraph shows that free flow conditions were maintained throughout the monitoring period. No surcharge conditions were recorded. Flow in this line is subcritical.

Flow depth and velocity measurements recorded by the flow monitor are consistent with field confirmations conducted and support the relative accuracy of the flow monitor at this location.

Site FM01altB was positioned downstream of FM02 and FM03. A flow balancing check was completed, and no problems were noted. An average net flow of 0.295 mgd was reported for the study period.

OBSERVATIONS

Average flow depth, velocity, and quantity data observed during **Friday, October 23, 2020 to Saturday, November 28, 2020**, along with observed minimum and maximum data, are provided in the following table.

Observed Flow Conditions			
Item	DFINAL (in)	VFINAL (ft/s)	QFINAL (MGD - Total MG)
Average	4.75	1.87	0.560
Minimum	2.23	0.97	0.100
Maximum	7.11	2.68	1.261
Min Time	11/22/2020 05:10:00	10/23/2020 03:00:00	10/23/2020 03:00:00
Max Time	11/26/2020 11:00:00	11/24/2020 08:25:00	11/08/2020 10:20:00

Based upon the quality and consistency of the observed flow depth and velocity data, the Continuity equation was used to calculate flow rate and quantities during the monitoring period.

Values in the Observed Flow Conditions and data on the graphical reports are based on the five-minute average.

DATA UPTIME

Data uptime observed during **Friday, October 23, 2020 to Saturday, November 28, 2020** is provided in the following table:

Percent Uptime	
DFINAL (in)	100
VFINAL (ft/s)	100
QFINAL (MGD - Total MG)	100

Project Name: Nipomo MKN TFM 2020		City: Nipomo		Agency: Nipomo		FM Initials: SK	
Site Name: FM01		Install Date: 10/22/20		Monitor Type: Peak Doppler			
Address/Location: 509 Southland St (Located on Old Windmill PI)				Monitor Model: Triton +			
				Data Acquisition: Manual/Wireless Collect			
				Manhole ID:			
Access: Drive		Type of System:		Pipe Height: 23.38 "			
		Sanitary <input checked="" type="checkbox"/>		Storm <input type="checkbox"/>		Combined <input type="checkbox"/>	
				Pipe Width: 23.38 "			



Investigation Information: Manhole Information:

Date/Time of Investigation: 10/22/20 @02:20pm		Manhole Depth: 10	
Site Hydraulics: Good straight through flow		Manhole Material / Condition: Precast/Good	
Upstream Input: (L/S, P/S) --		Pipe Material / Condition: VCP/Good	
Upstream Manhole: Not Investigated		Land Use: Residential <input type="checkbox"/> Commercial <input type="checkbox"/> Industrial <input checked="" type="checkbox"/> Trunk <input type="checkbox"/>	
Downstream Manhole: Not investigated		Oxygen: 20.9 H2S: 0 LEL: 0 CO: 0	
Depth of Flow: 4.75 " +/- 0.25"		Safety Notes: 2 man crew required and one blower is to be operated at all times.	
Range (Air DOF): +/-			
Peak Velocity: 2.10 fps			
Silt: 0.00 Inches			

Other Information:

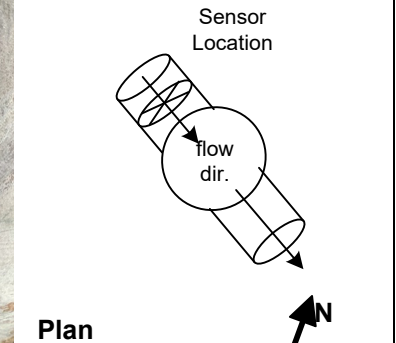
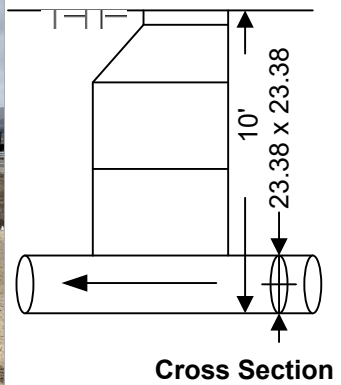

Installation Information		Backup	Yes	No	?	Distance
Installation Type:	Standard	Trunk	<input type="checkbox"/>	<input checked="" type="checkbox"/>	<input type="checkbox"/>	
Sensors Devices:	Ultrasonic/Velocity/Pressure	Lift / Pump Station	<input type="checkbox"/>	<input checked="" type="checkbox"/>	<input type="checkbox"/>	
Surcharge Height:	0	WWTP	<input type="checkbox"/>	<input checked="" type="checkbox"/>	<input type="checkbox"/>	
Rain Gauge Zone:		Other	<input type="checkbox"/>	<input checked="" type="checkbox"/>	<input type="checkbox"/>	

Additional Site Information / Comments:

Standard Traffic Control with No Safety Concerns

Hydrograph Report

FM01altB

Flow Monitor
FM01altB

Pipe Height
23.38
in

Report Period
10/23/2020
To
11/28/2020

Legend
— DFINAL
— VFINAL
— QFINAL
— RAIN FINAL

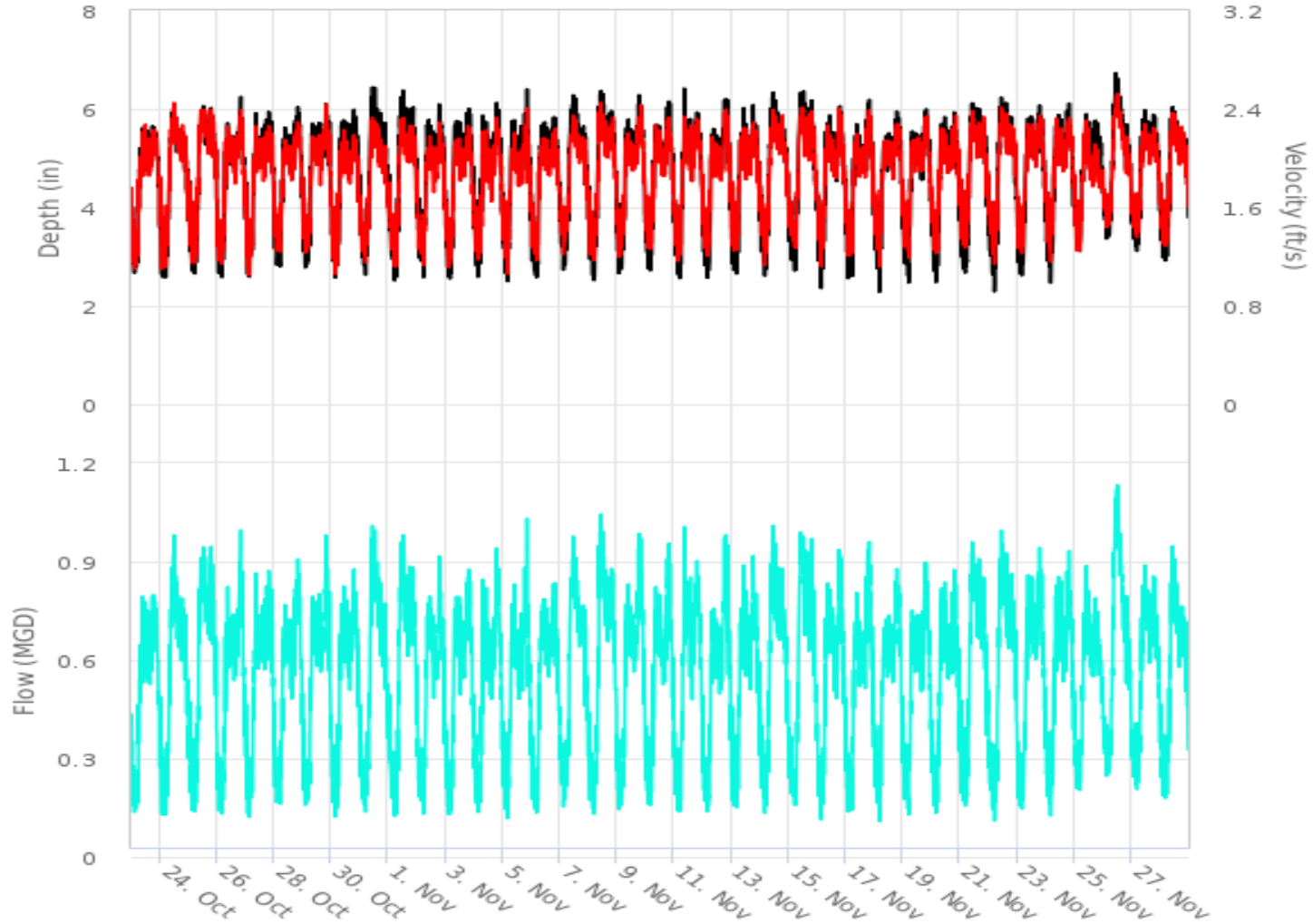

Scattergraph Report

FM01altB

Flow Monitor
FM01altB

Pipe Height
23.38
in

Report Period
10/23/2020
To
11/28/2020

Legend
○ DFINAL - VFINAL
--- Iso-Q™
▼ Min-Max Depth

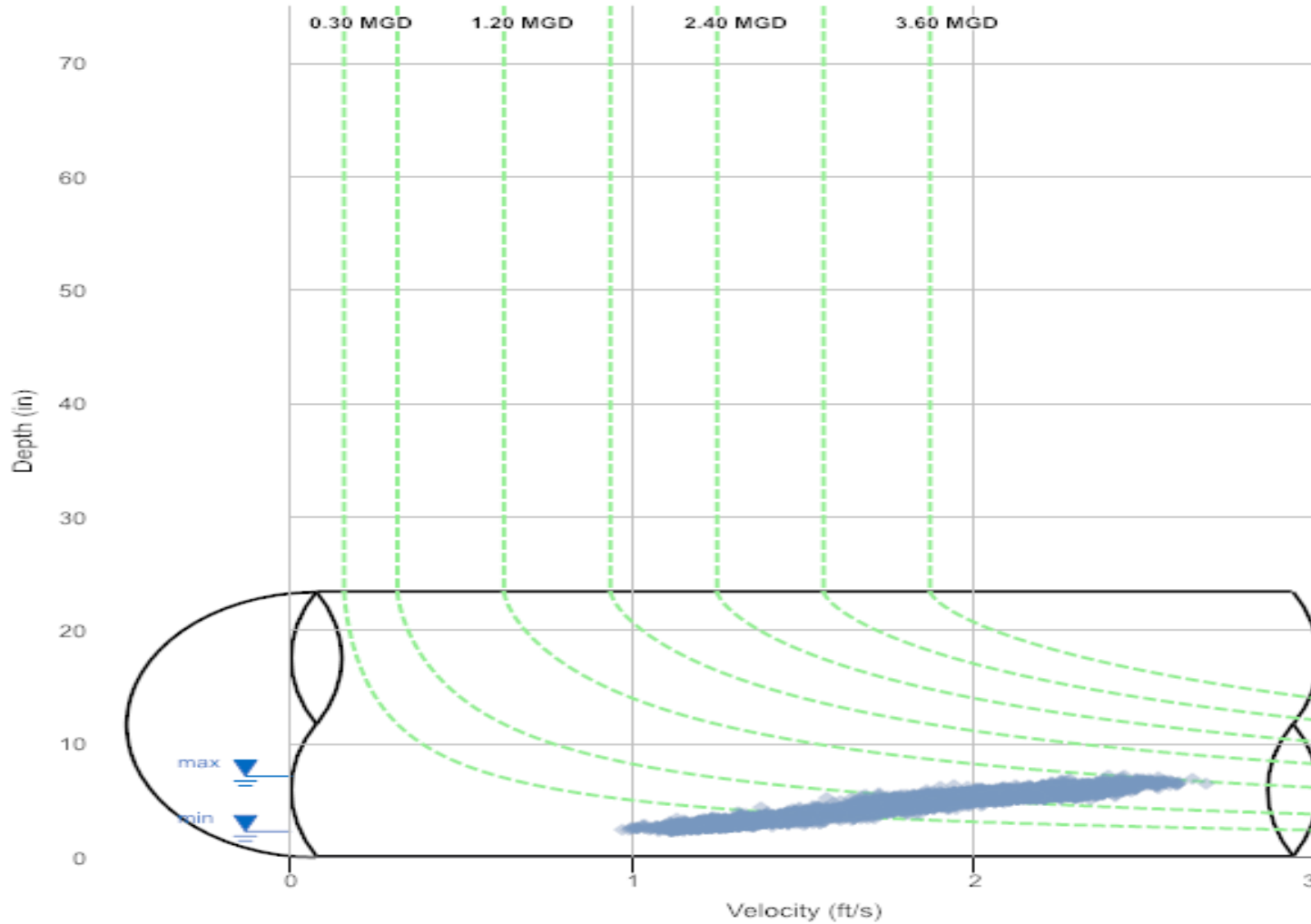

Daily Tabular Report

10/23/2020 00:00 - 11/28/2020 23:59
 FM01altBPipe: Round (23.38 in H), Silt0.00 in

Date	DFINAL (in)					VFINAL (ft/s)					QFINAL (MGD - Total MG)					Rain (in)		RAIN FINAL (in)		
	Time	Min	Time	Max	Avg	Time	Min	Time	Max	Avg	Time	Min	Time	Max	Avg	Total	Total			
10/23/2020	03:05	2.37	20:35	6.10	4.61	03:00	0.97	09:30	2.47	1.84	03:00	0.100	09:30	0.963	0.526	0.526	-	-	-	-
10/24/2020	05:15	2.50	12:05	6.46	4.64	01:55	1.08	13:55	2.50	1.88	01:55	0.122	12:05	1.081	0.552	0.552	-	-	-	-
10/25/2020	05:15	2.53	11:10	6.68	4.77	06:45	1.11	11:15	2.58	1.92	05:15	0.128	11:10	1.165	0.586	0.586	-	-	-	-
10/26/2020	04:15	2.52	20:20	6.58	4.66	01:50	1.11	20:20	2.54	1.87	04:15	0.124	20:20	1.129	0.544	0.544	-	-	-	-
10/27/2020	02:05	2.49	22:00	6.27	4.76	02:05	1.01	22:00	2.38	1.85	02:05	0.111	22:00	0.990	0.555	0.555	-	-	-	-
10/28/2020	03:05	2.62	21:25	6.43	4.74	03:05	1.17	21:25	2.44	1.87	03:05	0.138	21:25	1.052	0.554	0.554	-	-	-	-
10/29/2020	02:30	2.67	19:35	6.56	4.75	02:30	1.19	19:35	2.56	1.90	02:30	0.145	19:35	1.132	0.562	0.562	-	-	-	-
10/30/2020	03:40	2.46	19:20	6.78	4.77	03:40	1.00	19:20	2.52	1.80	03:40	0.108	19:20	1.169	0.540	0.540	-	-	-	-
10/31/2020	05:10	2.57	11:25	6.95	4.83	03:45	1.13	09:50	2.54	1.83	05:10	0.132	09:50	1.216	0.565	0.565	-	-	-	-
11/01/2020	05:30	2.39	12:30	6.67	4.84	06:40	1.05	12:30	2.47	1.85	05:25	0.114	12:30	1.118	0.576	0.576	-	-	-	-
11/02/2020	05:35	2.46	17:25	6.33	4.73	05:35	1.01	10:50	2.37	1.79	05:35	0.109	17:25	0.978	0.532	0.532	-	-	-	-
11/03/2020	04:00	2.45	18:25	6.52	4.75	02:40	1.08	18:25	2.38	1.83	02:40	0.117	18:25	1.047	0.546	0.546	-	-	-	-
11/04/2020	03:20	2.53	20:30	6.50	4.74	02:30	1.08	19:10	2.45	1.82	02:30	0.122	19:10	1.059	0.541	0.541	-	-	-	-
11/05/2020	04:00	2.41	20:30	6.72	4.70	04:20	1.00	10:00	2.47	1.82	04:20	0.109	20:30	1.117	0.535	0.535	-	-	-	-
11/06/2020	04:45	2.42	19:45	6.52	4.72	04:45	1.14	19:45	2.38	1.84	04:45	0.121	19:45	1.044	0.541	0.541	-	-	-	-
11/07/2020	03:10	2.60	13:45	6.71	4.82	03:40	1.16	11:45	2.40	1.88	03:10	0.138	13:45	1.033	0.573	0.573	-	-	-	-
11/08/2020	04:55	2.42	10:20	6.93	4.87	01:40	1.04	10:20	2.64	1.90	04:55	0.120	10:20	1.261	0.597	0.597	-	-	-	-
11/09/2020	04:20	2.51	18:45	6.80	4.79	01:50	1.17	20:05	2.55	1.88	04:20	0.130	20:05	1.172	0.568	0.568	-	-	-	-
11/10/2020	04:20	2.37	20:30	6.74	4.73	04:20	1.17	19:45	2.51	1.87	04:20	0.120	19:45	1.131	0.553	0.553	-	-	-	-
11/11/2020	04:55	2.48	08:35	6.66	4.73	03:05	1.12	19:25	2.58	1.89	04:50	0.131	19:25	1.149	0.561	0.561	-	-	-	-
11/12/2020	04:10	2.49	18:15	6.69	4.70	04:10	1.18	18:15	2.54	1.88	04:10	0.130	18:15	1.155	0.551	0.551	-	-	-	-
11/13/2020	04:45	2.55	18:35	6.57	4.71	00:55	1.14	10:30	2.45	1.88	04:45	0.132	18:35	1.071	0.550	0.550	-	-	-	-
11/14/2020	04:25	2.52	14:45	6.68	4.81	04:20	1.08	11:55	2.60	1.90	04:25	0.121	11:55	1.137	0.580	0.580	-	-	-	-
11/15/2020	06:25	2.57	12:10	6.85	4.83	06:00	1.19	11:00	2.59	1.93	06:30	0.142	12:10	1.166	0.597	0.597	-	-	-	-
11/16/2020	03:25	2.27	16:20	6.57	4.70	03:50	1.08	19:40	2.49	1.89	03:55	0.107	19:15	1.054	0.553	0.553	-	-	-	-
11/17/2020	04:20	2.52	20:40	6.56	4.66	02:10	1.17	20:40	2.55	1.88	02:10	0.133	20:40	1.132	0.546	0.546	-	-	-	-
11/18/2020	04:40	2.27	19:10	6.20	4.67	05:00	1.09	18:55	2.38	1.87	04:35	0.107	19:10	0.950	0.545	0.545	-	-	-	-
11/19/2020	05:10	2.40	18:25	6.50	4.69	03:05	1.13	18:25	2.54	1.89	05:10	0.122	18:25	1.111	0.551	0.551	-	-	-	-
11/20/2020	04:00	2.45	11:20	6.46	4.64	04:00	1.14	20:35	2.43	1.87	04:00	0.122	11:20	1.046	0.538	0.538	-	-	-	-
11/21/2020	04:40	2.51	09:15	6.47	4.72	05:45	1.19	09:15	2.59	1.90	05:45	0.134	09:15	1.125	0.569	0.569	-	-	-	-
11/22/2020	05:10	2.23	14:45	6.55	4.74	05:10	1.11	11:30	2.59	1.92	05:10	0.104	11:30	1.108	0.584	0.584	-	-	-	-
11/23/2020	04:10	2.58	17:45	6.42	4.69	03:50	1.18	19:40	2.54	1.91	02:45	0.140	19:40	1.078	0.562	0.562	-	-	-	-
11/24/2020	04:25	2.40	08:25	6.47	4.71	04:25	1.15	08:25	2.68	1.92	04:25	0.120	08:25	1.165	0.563	0.563	-	-	-	-
11/25/2020	02:30	3.14	11:40	6.36	4.84	04:55	1.15	10:20	2.47	1.82	04:55	0.182	18:10	1.009	0.548	0.548	-	-	-	-
11/26/2020	05:50	3.14	11:00	7.11	5.08	05:50	1.36	12:15	2.57	1.99	05:50	0.211	11:00	1.208	0.648	0.648	-	-	-	-
11/27/2020	04:50	2.99	10:55	6.45	4.83	04:50	1.31	10:55	2.45	1.90	04:50	0.189	10:55	1.062	0.573	0.573	-	-	-	-
11/28/2020	04:30	2.80	10:50	6.43	4.71	04:30	1.24	10:50	2.53	1.90	04:30	0.162	10:55	1.091	0.557	0.557	-	-	-	-

10/23/2020 00:00 - 11/28/2020 23:59

	DFINAL (in)	VFINAL (ft/s)	QFINAL (MGD - Total MG)	Rain (in)
Total			20.721	
Average	4.75	1.87	0.560	

FM02

Site Commentary

SITE INFORMATION

Pipe	Elliptical (12.5 in H x 12.75 in W)
Silt	0.00 (in)

OVERVIEW

FM02 functioned under normal conditions during the period Friday, October 23, 2020 to Saturday, November 28, 2020. The flow pattern at this site exhibits frequent changes in both depth and velocity throughout the day. The saw-toothed like pattern indicates the influence of pump station activity. Review of the Scattergraph shows that although this line was impacted by debris, free flow conditions were maintained throughout the monitoring period. No surcharge conditions were recorded. Flow in this line is subcritical.

Flow depth and velocity measurements recorded by the flow monitor are consistent with field confirmations conducted and support the relative accuracy of the flow monitor at this location.

Site FM02 along with FM03 was positioned upstream of FM01altB. (See FM01altB Site Commentary for Balancing Details).

OBSERVATIONS

Average flow depth, velocity, and quantity data observed during **Friday, October 23, 2020 to Saturday, November 28, 2020**, along with observed minimum and maximum data, are provided in the following table.

Observed Flow Conditions			
Item	DFINAL (in)	VFINAL (ft/s)	QFINAL (MGD - Total MG)
Average	2.95	1.42	0.191
Minimum	1.13	0.21	0.007
Maximum	6.74	3.00	0.926
Min Time	11/15/2020 04:40:00	11/26/2020 05:10:00	10/26/2020 03:55:00
Max Time	11/24/2020 08:05:00	11/24/2020 08:05:00	11/24/2020 08:05:00

Based upon the quality and consistency of the observed flow depth and velocity data, the Continuity equation was used to calculate flow rate and quantities during the monitoring period.

Values in the Observed Flow Conditions and data on the graphical reports are based on the five-minute average.

DATA UPTIME

Data uptime observed during **Friday, October 23, 2020 to Saturday, November 28, 2020** is provided in the following table:

Percent Uptime	
DFINAL (in)	100
VFINAL (ft/s)	100
QFINAL (MGD - Total MG)	100

Project Name: Nipomo MKN TFM 2020		City: Nipomo		Agency: Nipomo		FM Initials: SK	
Site Name: FM02		Install Date: 10/22/20		Monitor Type: Peak Doppler			
Address/Location: 525 S Oak Glen				Monitor Model: Triton +			
				Data Acquisition: Manual/Wireless Collect			
				Manhole ID:			
Access: Drive		Type of System:		Pipe Height: 12.50 "			
		Sanitary <input checked="" type="checkbox"/>		Storm <input type="checkbox"/>		Combined <input type="checkbox"/>	
				Pipe Width: 12.75 "			

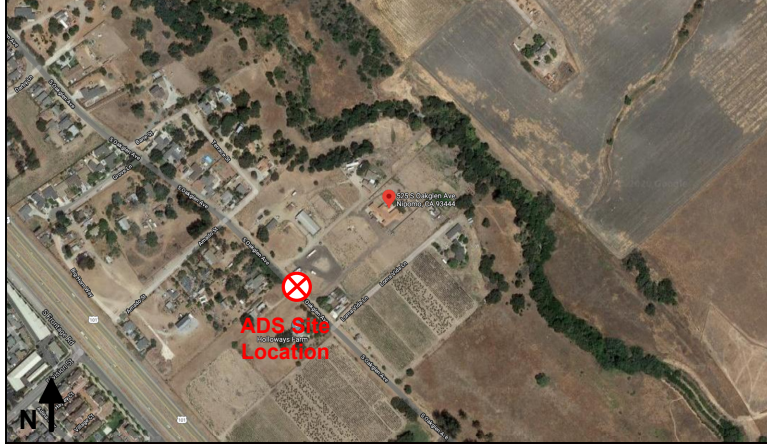

Investigation Information: Manhole Information:

Date/Time of Investigation: 10/22/20 @03:35pm		Manhole Depth: 14'	
Site Hydraulics: Good straight through flow		Manhole Material / Condition: Precast/Good	
Upstream Input: (L/S, P/S) --		Pipe Material / Condition: VCP/Good	
Upstream Manhole: Not Investigated		Land Use: Residential <input checked="" type="checkbox"/> Commercial <input type="checkbox"/> Industrial <input type="checkbox"/> Trunk <input type="checkbox"/>	
Downstream Manhole: Not investigated		Oxygen: 20.9 H2S: 0 LEL: 0 CO: 0	
Depth of Flow: 3.25 " +/- 0.25"		Safety Notes: 2 man crew required and one blower is to be operated at all times.	
Range (Air DOF): +/-			
Peak Velocity: 2.10 fps			
Silt: 0.00 Inches			

Other Information:

Cross Section

Plan

Installation Information		Backup		Yes	No	?	Distance
Installation Type:	Standard	Trunk		<input type="checkbox"/>	<input checked="" type="checkbox"/>	<input type="checkbox"/>	
Sensors Devices:	Ultrasonic/Velocity/Pressure	Lift / Pump Station		<input type="checkbox"/>	<input checked="" type="checkbox"/>	<input type="checkbox"/>	
Surcharge Height:	0	WWTP		<input type="checkbox"/>	<input checked="" type="checkbox"/>	<input type="checkbox"/>	
Rain Gauge Zone:		Other		<input type="checkbox"/>	<input checked="" type="checkbox"/>	<input type="checkbox"/>	

Additional Site Information / Comments:

Standard Traffic Control with No Safety Concerns

Hydrograph Report

FM02

Flow Monitor
FM02

Pipe Height
12.50
in

Report Period
10/23/2020
To
11/28/2020

Legend
— DFINAL
— VFINAL
— QFINAL
— RAIN FINAL

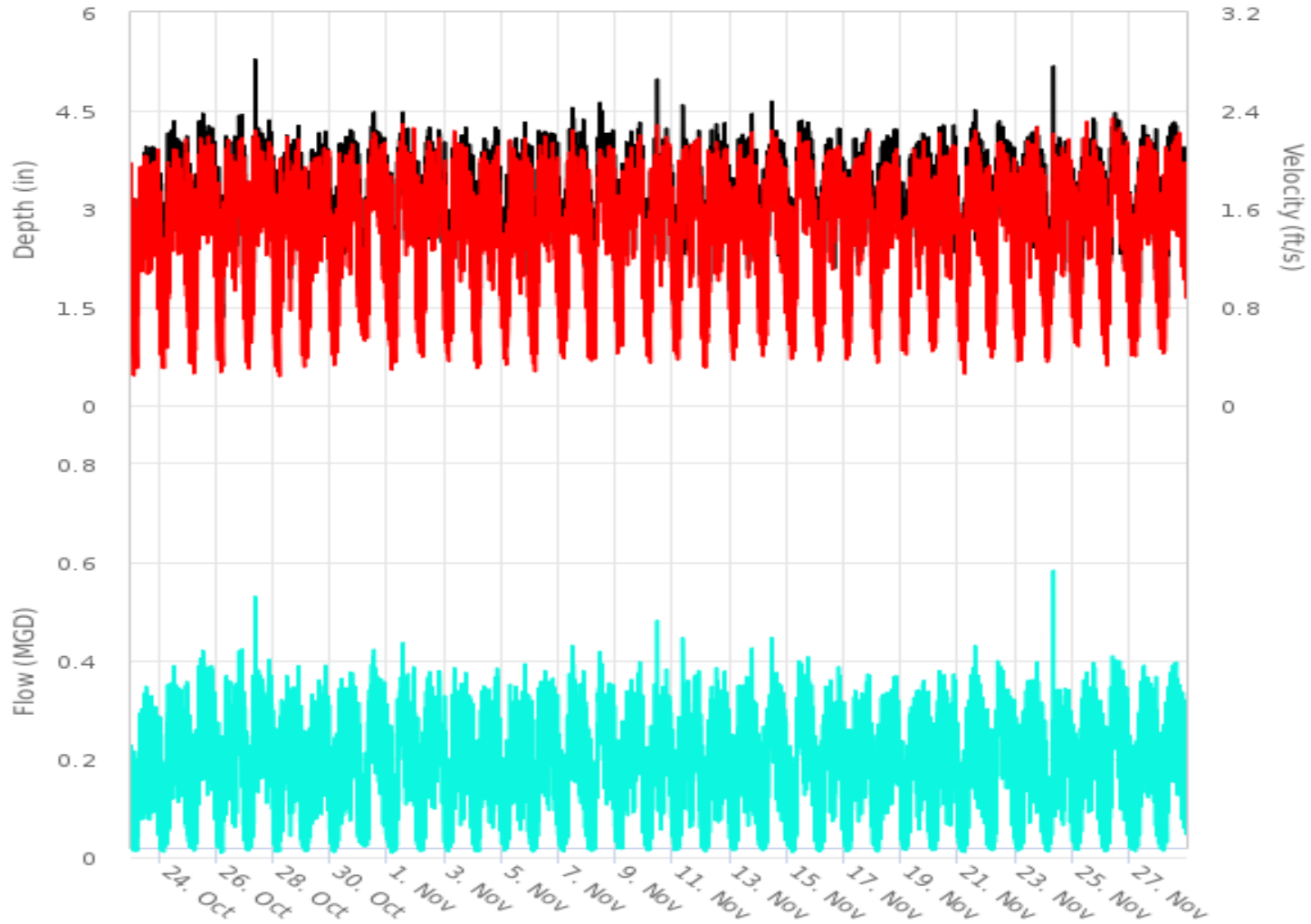

Scattergraph Report

FM02

Flow Monitor
FM02

Pipe Height
12.50
in

Report Period
10/23/2020
To
11/28/2020

Legend
○ DFINAL - VFINAL
--- Iso-Q™
▼ Min-Max Depth

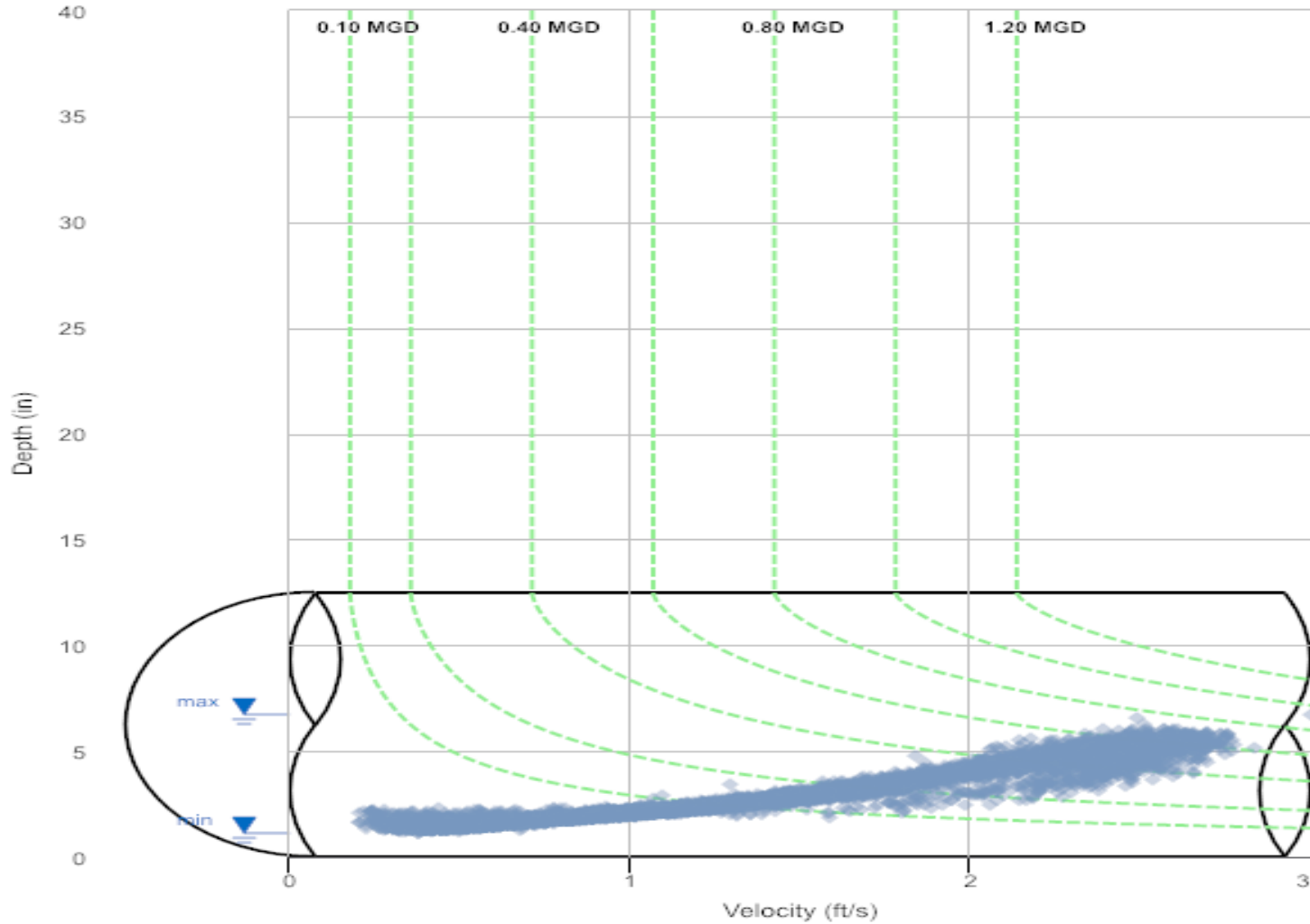

Daily Tabular Report

10/23/2020 00:00 - 11/28/2020 23:59

FM02Pipe: Elliptical (12.5 in H x 12.75 in W), Silt0.00 in

Date	DFINAL (in)					VFINAL (ft/s)					QFINAL (MGD - Total MG)					Rain (in)		RAIN FINAL (in)				
	Time	Min	Time	Max	Avg	Time	Min	Time	Max	Avg	Time	Min	Time	Max	Avg	Total	Total					
10/23/2020	04:00	1.47	12:45	5.41	2.81	02:20	0.21	12:45	2.70	1.35	04:00	0.012	12:45	0.629	0.166	0.166	-	-	-	-	-	-
10/24/2020	01:25	1.41	13:35	5.97	3.00	04:00	0.23	12:55	2.71	1.38	03:55	0.009	13:35	0.689	0.192	0.192	-	-	-	-	-	-
10/25/2020	06:15	1.42	12:20	6.09	3.15	05:15	0.22	19:50	2.76	1.45	05:15	0.010	12:20	0.699	0.213	0.213	-	-	-	-	-	-
10/26/2020	04:05	1.27	19:40	6.04	2.98	03:55	0.23	18:45	2.76	1.40	03:55	0.007	18:45	0.705	0.194	0.194	-	-	-	-	-	-
10/27/2020	05:35	1.47	08:40	6.28	3.14	03:25	0.25	08:25	2.84	1.46	02:00	0.012	08:40	0.710	0.212	0.212	-	-	-	-	-	-
10/28/2020	02:30	1.38	20:10	5.82	2.99	05:10	0.21	11:00	2.70	1.38	02:30	0.009	20:10	0.644	0.189	0.189	-	-	-	-	-	-
10/29/2020	04:35	1.31	19:50	5.87	2.96	01:55	0.31	19:50	2.70	1.41	04:30	0.012	19:50	0.700	0.189	0.189	-	-	-	-	-	-
10/30/2020	02:35	1.27	20:55	5.93	2.90	03:10	0.31	18:40	2.75	1.38	03:05	0.010	20:55	0.694	0.184	0.184	-	-	-	-	-	-
10/31/2020	01:50	1.50	09:10	5.96	3.02	23:40	0.36	10:45	2.78	1.47	04:25	0.019	11:20	0.682	0.203	0.203	-	-	-	-	-	-
11/01/2020	04:55	1.31	10:05	5.93	2.93	03:30	0.29	08:05	2.74	1.42	03:30	0.009	13:45	0.672	0.192	0.192	-	-	-	-	-	-
11/02/2020	03:10	1.27	09:50	5.51	2.92	05:30	0.36	12:50	2.74	1.42	03:10	0.012	14:55	0.634	0.188	0.188	-	-	-	-	-	-
11/03/2020	03:20	1.24	18:05	6.04	2.88	03:35	0.35	08:05	2.67	1.40	03:25	0.011	18:05	0.703	0.184	0.184	-	-	-	-	-	-
11/04/2020	04:30	1.32	20:05	5.61	2.88	03:10	0.29	20:05	2.66	1.37	03:10	0.010	20:05	0.648	0.180	0.180	-	-	-	-	-	-
11/05/2020	02:30	1.30	13:10	5.53	2.91	04:00	0.28	08:10	2.59	1.36	02:30	0.010	19:50	0.609	0.177	0.177	-	-	-	-	-	-
11/06/2020	02:35	1.34	10:50	5.72	2.99	04:00	0.24	10:50	2.66	1.40	02:20	0.011	10:50	0.666	0.190	0.190	-	-	-	-	-	-
11/07/2020	03:15	1.28	09:25	5.86	3.09	03:20	0.31	11:35	2.72	1.45	03:15	0.010	12:50	0.672	0.204	0.204	-	-	-	-	-	-
11/08/2020	03:40	1.39	11:05	5.95	3.09	03:50	0.30	10:15	2.66	1.41	03:50	0.011	10:15	0.679	0.200	0.200	-	-	-	-	-	-
11/09/2020	05:15	1.34	18:10	5.81	3.00	01:25	0.35	11:40	2.62	1.47	05:10	0.014	18:10	0.658	0.195	0.195	-	-	-	-	-	-
11/10/2020	02:30	1.30	10:45	6.08	2.87	02:25	0.32	07:40	2.66	1.42	02:25	0.011	10:45	0.649	0.181	0.181	-	-	-	-	-	-
11/11/2020	01:50	1.25	08:20	5.97	2.92	03:00	0.33	17:50	2.76	1.44	03:00	0.011	17:50	0.690	0.191	0.191	-	-	-	-	-	-
11/12/2020	05:20	1.27	19:30	5.69	2.91	02:00	0.30	13:40	2.65	1.43	01:55	0.010	20:10	0.621	0.188	0.188	-	-	-	-	-	-
11/13/2020	03:25	1.19	18:30	5.59	2.91	03:20	0.34	18:30	2.75	1.43	03:25	0.009	18:30	0.669	0.187	0.187	-	-	-	-	-	-
11/14/2020	05:35	1.36	10:10	5.67	2.96	03:50	0.38	16:05	2.65	1.44	03:50	0.014	11:00	0.634	0.194	0.194	-	-	-	-	-	-
11/15/2020	04:40	1.13	17:30	5.86	3.00	05:00	0.30	17:30	2.76	1.46	04:30	0.010	17:30	0.713	0.201	0.201	-	-	-	-	-	-
11/16/2020	01:50	1.28	19:15	5.63	2.91	02:55	0.35	19:15	2.75	1.44	02:45	0.012	19:15	0.675	0.188	0.188	-	-	-	-	-	-
11/17/2020	03:25	1.26	08:10	5.64	2.92	02:25	0.36	19:25	2.66	1.43	02:25	0.011	19:25	0.633	0.185	0.185	-	-	-	-	-	-
11/18/2020	03:50	1.29	12:40	5.66	2.94	04:10	0.32	18:40	2.68	1.42	04:05	0.011	18:40	0.653	0.188	0.188	-	-	-	-	-	-
11/19/2020	03:00	1.29	20:05	5.65	2.89	04:25	0.37	11:20	2.63	1.38	03:25	0.013	20:05	0.618	0.178	0.178	-	-	-	-	-	-
11/20/2020	01:55	1.28	08:25	5.85	2.91	02:15	0.39	12:00	2.64	1.43	02:05	0.013	12:00	0.668	0.186	0.186	-	-	-	-	-	-
11/21/2020	04:05	1.28	12:05	5.79	2.90	05:25	0.25	16:50	2.69	1.41	05:20	0.010	12:05	0.668	0.185	0.185	-	-	-	-	-	-
11/22/2020	04:15	1.20	09:00	5.79	2.97	04:15	0.33	09:00	2.76	1.45	04:15	0.009	09:00	0.703	0.197	0.197	-	-	-	-	-	-
11/23/2020	02:10	1.37	17:35	5.46	2.94	05:00	0.34	11:10	2.70	1.44	02:10	0.012	17:35	0.611	0.189	0.189	-	-	-	-	-	-
11/24/2020	04:20	1.26	08:05	6.74	2.93	02:50	0.33	08:05	3.00	1.44	02:50	0.011	08:05	0.926	0.192	0.192	-	-	-	-	-	-
11/25/2020	02:00	1.31	08:55	5.83	2.93	05:10	0.45	08:55	2.74	1.46	05:10	0.014	08:55	0.705	0.194	0.194	-	-	-	-	-	-
11/26/2020	02:45	1.28	12:35	5.91	3.00	05:10	0.21	18:30	2.72	1.49	05:10	0.009	12:50	0.683	0.205	0.205	-	-	-	-	-	-
11/27/2020	05:05	1.25	12:15	5.90	2.88	01:35	0.27	17:40	2.73	1.42	05:00	0.011	12:15	0.706	0.187	0.187	-	-	-	-	-	-
11/28/2020	04:35	1.28	11:45	6.07	3.00	05:45	0.38	13:00	2.77	1.48	04:25	0.012	11:45	0.704	0.202	0.202	-	-	-	-	-	-

10/23/2020 00:00 - 11/28/2020 23:59

	DFINAL (in)	VFINAL (ft/s)	QFINAL (MGD - Total MG)	Rain (in)
Total			7.071	
Average	2.95	1.42	0.191	

FM03

Site Commentary

SITE INFORMATION

Pipe	Round (9.88 in H)
Silt	0.00 (in)

OVERVIEW

FM03 functioned under normal conditions during the period Friday, October 23, 2020 to Saturday, November 28, 2020. The flow pattern at this site exhibits frequent changes in both depth and velocity throughout the day. The saw-toothed like pattern indicates the influence of pump station activity. Review of the Scattergraph shows that free flow conditions were maintained throughout the monitoring period. No surcharge conditions were recorded. Flow in this line is subcritical.

Flow depth and velocity measurements recorded by the flow monitor are consistent with field confirmations conducted and support the relative accuracy of the flow monitor at this location.

Site FM03 along with FM02 was positioned upstream of FM01altB. (See FM01altB Site Commentary for Balancing Details).

OBSERVATIONS

Average flow depth, velocity, and quantity data observed during **Friday, October 23, 2020 to Saturday, November 28, 2020**, along with observed minimum and maximum data, are provided in the following table.

Observed Flow Conditions			
Item	DFINAL (in)	VFINAL (ft/s)	QFINAL (MGD - Total MG)
Average	2.25	1.14	0.074
Minimum	0.92	0.31	0.005
Maximum	4.12	1.83	0.248
Min Time	11/13/2020 05:15:00	11/05/2020 04:25:00	11/05/2020 04:25:00
Max Time	11/26/2020 09:55:00	11/26/2020 09:55:00	11/26/2020 09:55:00

Based upon the quality and consistency of the observed flow depth and velocity data, the Continuity equation was used to calculate flow rate and quantities during the monitoring period.

Values in the Observed Flow Conditions and data on the graphical reports are based on the five-minute average.

DATA UPTIME

Data uptime observed during **Friday, October 23, 2020 to Saturday, November 28, 2020** is provided in the following table:

Percent Uptime	
DFINAL (in)	100
VFINAL (ft/s)	100
QFINAL (MGD - Total MG)	100

Project Name: Nipomo MKN TFM 2020		City: Nipomo		Agency: Nipomo		FM Initials: SK	
Site Name: FM03		Install Date: 10/22/20		Monitor Type: Peak Doppler			
Address/Location: Frontage Rd & Hill St				Monitor Model: Triton +			
				Data Acquisition: Manual/Wireless Collect			
				Manhole ID:			
Access: Drive		Type of System:		Pipe Height: 10.88 "			
		Sanitary <input checked="" type="checkbox"/>		Storm <input type="checkbox"/>		Combined <input type="checkbox"/>	
				Pipe Width: 10.63 "			

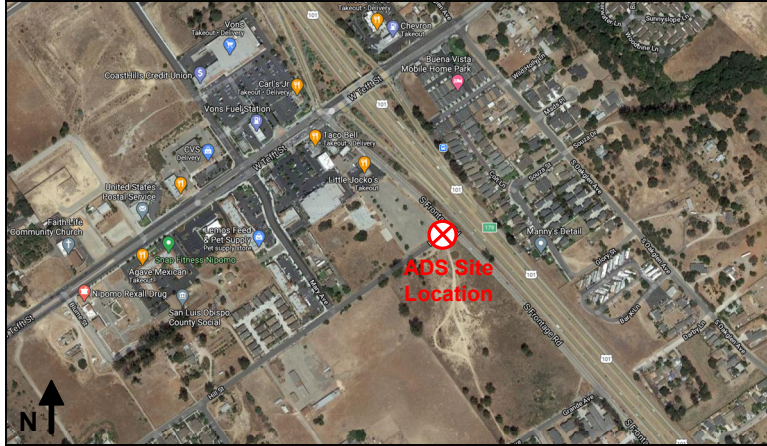

Investigation Information: Manhole Information:

Date/Time of Investigation: 10/22/20 @04:40pm		Manhole Depth: 14'	
Site Hydraulics: Good straight through flow		Manhole Material / Condition: Precast/Good	
Upstream Input: (L/S, P/S) --		Pipe Material / Condition: VCP/Good	
Upstream Manhole: Not Investigated		Land Use: Residential <input checked="" type="checkbox"/> Commercial <input type="checkbox"/> Industrial <input type="checkbox"/> Trunk <input type="checkbox"/>	
Downstream Manhole: Not investigated		Oxygen: 20.9 H2S: 0 LEL: 0 CO: 0	
Depth of Flow: 2.63 " +/- 0.25"		Safety Notes: 2 man crew required and one blower is to be operated at all times.	
Range (Air DOF): +/-			
Peak Velocity: 1.54 fps			
Silt: 0.00 Inches			

Other Information:

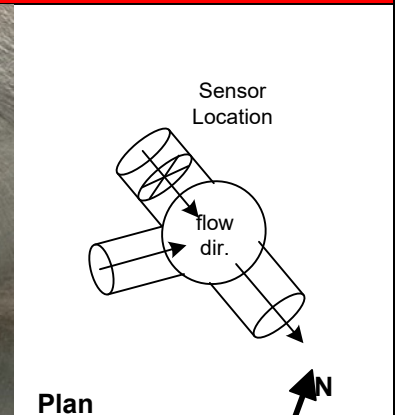
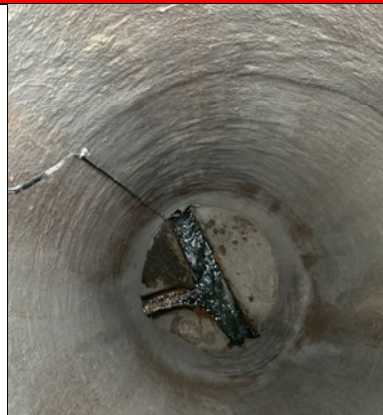
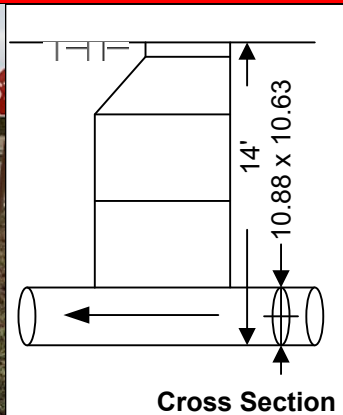

Installation Information		Backup		Yes	No	?	Distance
Installation Type:	Standard	Trunk		<input type="checkbox"/>	<input checked="" type="checkbox"/>	<input type="checkbox"/>	
Sensors Devices:	Ultrasonic/Velocity/Pressure	Lift / Pump Station		<input type="checkbox"/>	<input checked="" type="checkbox"/>	<input type="checkbox"/>	
Surcharge Height:	0	WWTP		<input type="checkbox"/>	<input checked="" type="checkbox"/>	<input type="checkbox"/>	
Rain Gauge Zone:		Other		<input type="checkbox"/>	<input checked="" type="checkbox"/>	<input type="checkbox"/>	

Additional Site Information / Comments:

Standard Traffic Control with No Safety Concerns

Hydrograph Report

FM03

Flow Monitor
FM03

Pipe Height
9.88
in

Report Period
10/23/2020
To
11/28/2020

Legend
— DFINAL
— VFINAL
— QFINAL
— RAIN FINAL

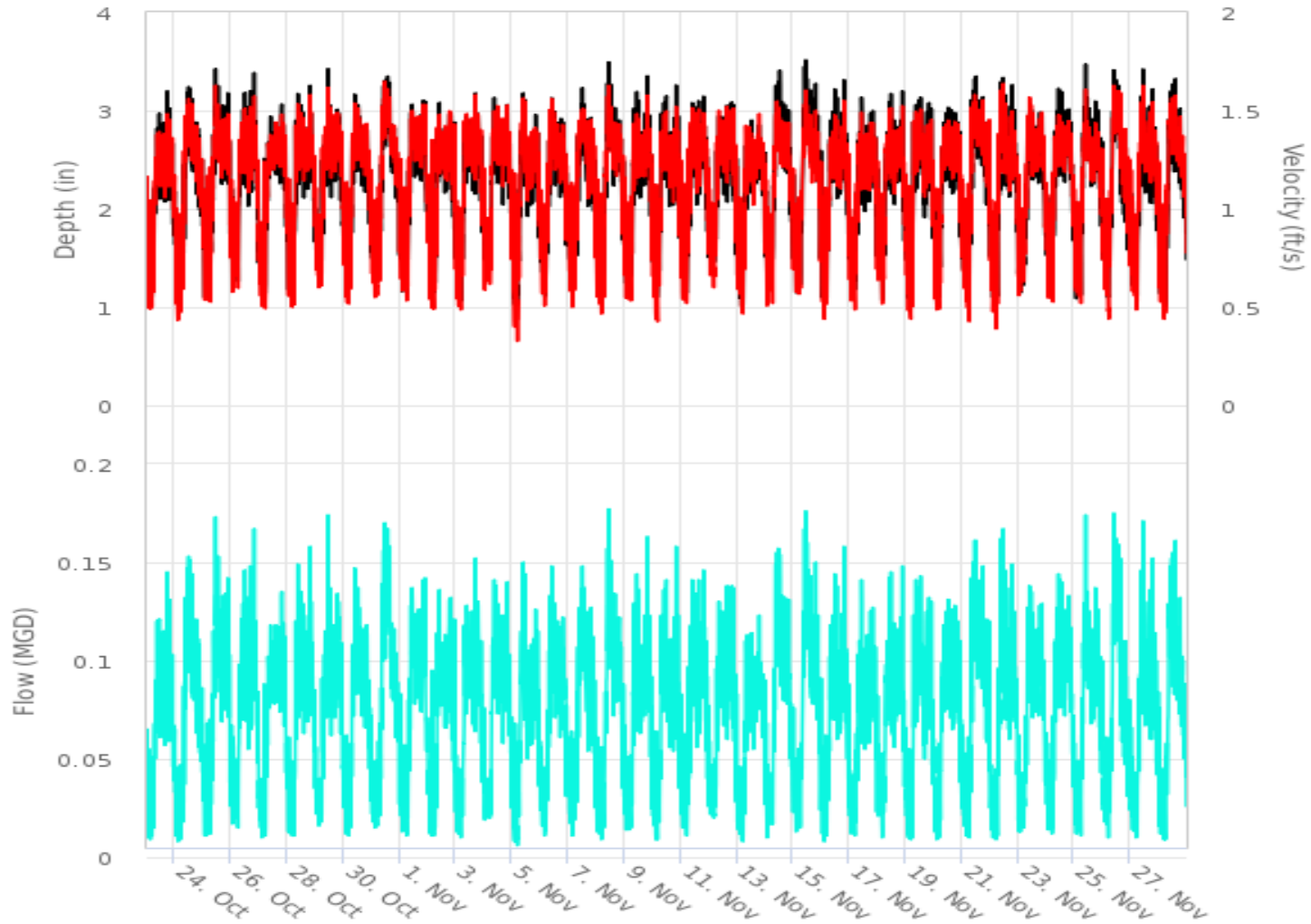

Scattergraph Report

FM03

Flow Monitor
FM03

Pipe Height
9.88
in

Report Period
10/23/2020
To
11/28/2020

Legend
○ DFINAL - VFINAL
--- Iso-Q™
▼ Min-Max Depth

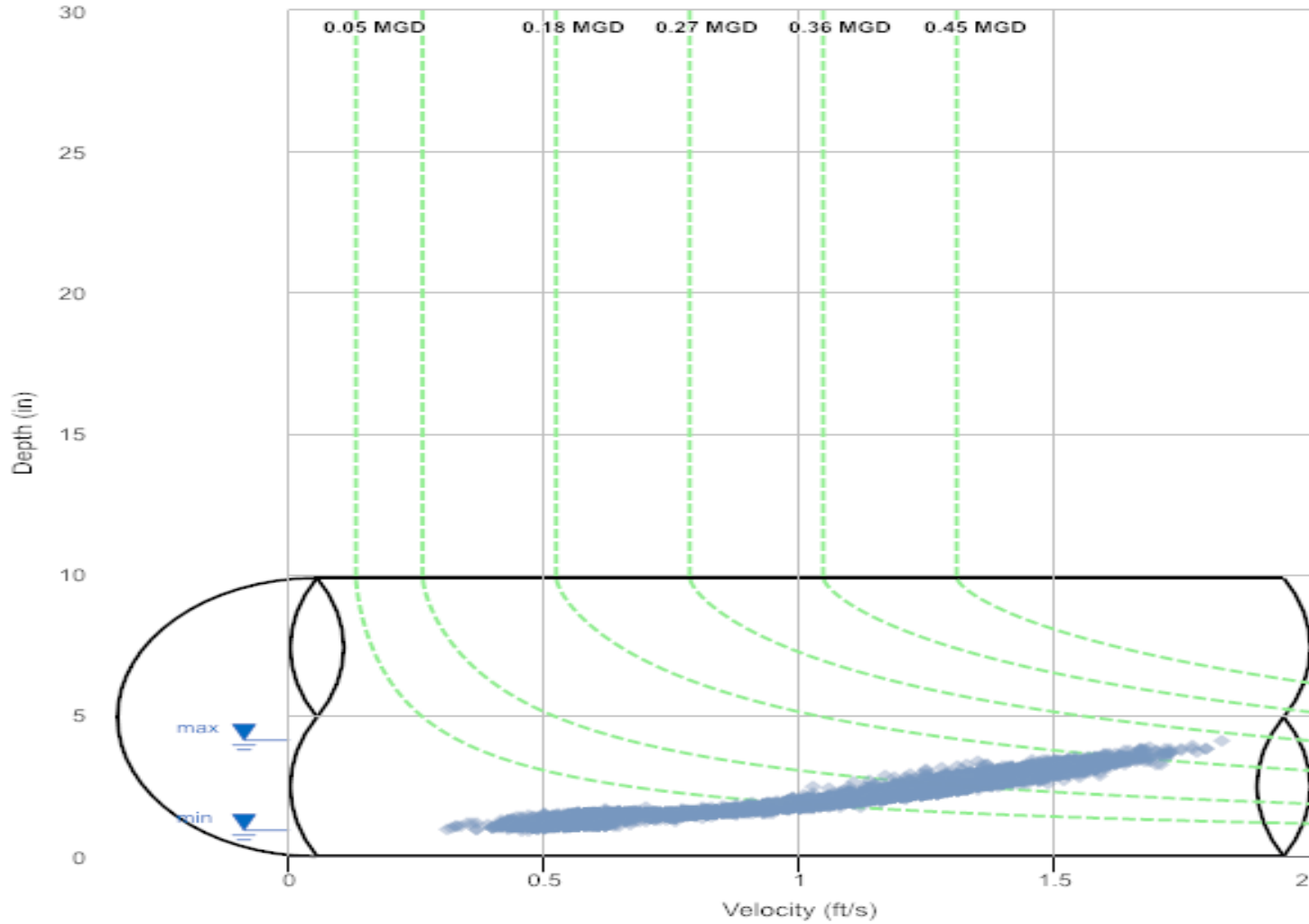

Daily Tabular Report

10/23/2020 00:00 - 11/28/2020 23:59
FM03Pipe: Round (9.88 in H), Silt0.00 in

Date	DFINAL (in)					VFINAL (ft/s)					QFINAL (MGD - Total MG)					Rain (in)	RAIN FINAL (in)					
	Time	Min	Time	Max	Avg	Time	Min	Time	Max	Avg	Time	Min	Time	Max	Avg	Total	Total					
10/23/2020	02:30	0.93	08:50	3.54	2.18	02:30	0.37	08:50	1.64	1.10	02:30	0.006	08:50	0.182	0.069	0.069	-	-	-	-	-	-
10/24/2020	02:50	0.99	13:15	3.71	2.21	02:45	0.42	13:15	1.70	1.12	02:25	0.008	13:15	0.201	0.073	0.073	-	-	-	-	-	-
10/25/2020	01:35	1.08	13:05	3.63	2.27	06:45	0.45	10:45	1.72	1.14	03:15	0.010	10:45	0.196	0.076	0.076	-	-	-	-	-	-
10/26/2020	06:10	1.18	19:50	3.83	2.29	23:40	0.54	19:50	1.75	1.16	06:10	0.013	19:50	0.216	0.076	0.076	-	-	-	-	-	-
10/27/2020	02:30	1.04	16:25	3.74	2.27	02:30	0.48	16:25	1.70	1.14	02:30	0.009	16:25	0.203	0.075	0.075	-	-	-	-	-	-
10/28/2020	05:35	1.07	19:30	3.63	2.25	04:30	0.48	19:30	1.72	1.16	05:35	0.010	19:30	0.197	0.075	0.075	-	-	-	-	-	-
10/29/2020	03:10	1.21	10:45	3.83	2.27	03:20	0.57	10:45	1.80	1.18	03:10	0.014	10:45	0.222	0.077	0.077	-	-	-	-	-	-
10/30/2020	02:15	1.08	10:55	3.55	2.23	02:10	0.50	10:55	1.65	1.15	02:15	0.010	10:55	0.184	0.074	0.074	-	-	-	-	-	-
10/31/2020	05:05	1.09	13:45	3.72	2.32	05:05	0.49	11:20	1.78	1.17	05:05	0.010	11:20	0.210	0.080	0.080	-	-	-	-	-	-
11/01/2020	02:35	1.08	10:45	3.67	2.29	06:20	0.51	16:40	1.63	1.17	02:25	0.011	10:45	0.188	0.078	0.078	-	-	-	-	-	-
11/02/2020	03:20	0.97	19:55	3.30	2.22	05:05	0.47	19:50	1.62	1.13	03:20	0.009	19:50	0.162	0.072	0.072	-	-	-	-	-	-
11/03/2020	04:30	1.04	16:45	3.41	2.21	02:30	0.44	16:45	1.66	1.14	02:25	0.009	16:45	0.174	0.072	0.072	-	-	-	-	-	-
11/04/2020	05:20	1.11	10:05	3.51	2.25	04:00	0.52	20:05	1.69	1.16	04:00	0.012	10:05	0.183	0.074	0.074	-	-	-	-	-	-
11/05/2020	04:20	0.96	09:35	3.54	2.16	04:25	0.31	09:35	1.68	1.11	04:25	0.005	09:35	0.186	0.069	0.069	-	-	-	-	-	-
11/06/2020	04:55	1.03	09:50	3.49	2.24	03:45	0.48	09:50	1.72	1.15	03:45	0.010	09:50	0.187	0.074	0.074	-	-	-	-	-	-
11/07/2020	03:30	1.13	09:55	3.58	2.24	03:45	0.47	09:55	1.72	1.15	03:30	0.011	09:55	0.194	0.074	0.074	-	-	-	-	-	-
11/08/2020	04:10	1.02	13:40	3.80	2.27	04:25	0.45	13:40	1.72	1.14	02:50	0.009	13:40	0.210	0.076	0.076	-	-	-	-	-	-
11/09/2020	00:30	1.04	19:30	3.55	2.24	04:00	0.43	19:30	1.65	1.13	04:00	0.009	19:30	0.183	0.072	0.072	-	-	-	-	-	-
11/10/2020	03:55	1.02	20:05	3.84	2.23	02:50	0.41	20:05	1.73	1.11	02:50	0.008	20:05	0.215	0.072	0.072	-	-	-	-	-	-
11/11/2020	04:15	1.05	19:40	3.91	2.25	05:15	0.51	19:40	1.77	1.13	05:00	0.010	19:40	0.224	0.074	0.074	-	-	-	-	-	-
11/12/2020	04:35	1.45	19:25	3.73	2.27	04:15	0.57	19:25	1.75	1.17	04:15	0.020	19:25	0.208	0.075	0.075	-	-	-	-	-	-
11/13/2020	05:10	0.92	07:40	3.27	2.17	05:20	0.43	07:40	1.71	1.12	05:10	0.007	07:40	0.170	0.069	0.069	-	-	-	-	-	-
11/14/2020	01:40	1.03	09:10	3.73	2.34	02:00	0.47	10:20	1.73	1.14	02:00	0.009	10:20	0.201	0.079	0.079	-	-	-	-	-	-
11/15/2020	02:35	1.10	11:50	3.87	2.36	02:40	0.55	11:50	1.69	1.14	02:35	0.012	11:50	0.211	0.080	0.080	-	-	-	-	-	-
11/16/2020	02:40	1.00	19:35	3.61	2.23	02:40	0.40	19:35	1.70	1.10	02:40	0.007	19:35	0.193	0.071	0.071	-	-	-	-	-	-
11/17/2020	05:05	1.04	10:20	3.50	2.19	04:55	0.46	10:20	1.64	1.11	04:55	0.009	10:20	0.179	0.070	0.070	-	-	-	-	-	-
11/18/2020	04:05	1.06	10:00	3.66	2.24	04:05	0.51	10:00	1.71	1.14	04:05	0.010	10:00	0.198	0.072	0.072	-	-	-	-	-	-
11/19/2020	02:40	1.02	08:55	3.51	2.25	04:30	0.43	19:55	1.64	1.14	02:40	0.009	08:55	0.179	0.075	0.075	-	-	-	-	-	-
11/20/2020	02:35	1.03	15:10	3.31	2.24	04:45	0.43	11:25	1.53	1.14	02:35	0.009	12:35	0.151	0.073	0.073	-	-	-	-	-	-
11/21/2020	04:05	1.06	15:40	3.84	2.28	06:20	0.42	15:40	1.80	1.17	06:25	0.009	15:40	0.222	0.078	0.078	-	-	-	-	-	-
11/22/2020	00:30	1.04	10:20	3.77	2.26	05:10	0.35	11:20	1.69	1.14	05:10	0.008	10:20	0.202	0.076	0.076	-	-	-	-	-	-
11/23/2020	00:10	1.10	09:45	3.28	2.20	00:40	0.47	09:45	1.70	1.15	00:10	0.010	09:45	0.169	0.072	0.072	-	-	-	-	-	-
11/24/2020	05:05	1.08	19:25	3.84	2.33	05:50	0.49	19:25	1.68	1.15	05:50	0.010	19:25	0.208	0.078	0.078	-	-	-	-	-	-
11/25/2020	02:25	1.05	09:50	3.77	2.33	02:30	0.50	09:50	1.64	1.15	02:30	0.010	09:50	0.198	0.078	0.078	-	-	-	-	-	-
11/26/2020	05:30	1.08	09:55	4.12	2.25	05:45	0.42	09:55	1.83	1.15	05:15	0.009	09:55	0.248	0.076	0.076	-	-	-	-	-	-
11/27/2020	00:00	1.04	19:00	3.56	2.22	04:55	0.46	19:00	1.65	1.14	04:55	0.009	19:00	0.184	0.073	0.073	-	-	-	-	-	-
11/28/2020	05:50	0.98	14:35	3.69	2.22	04:45	0.44	14:35	1.73	1.14	05:55	0.008	14:35	0.202	0.075	0.075	-	-	-	-	-	-

10/23/2020 00:00 - 11/28/2020 23:59

	DFINAL (in)	VFINAL (ft/s)	QFINAL (MGD - Total MG)	Rain (in)
Total			2.752	
Average	2.25	1.14	0.074	

APPENDIX B

DWG: P:\nipomo_csd (19996)\southland_wrf_upgrades\000_cadd (2010)\Process\conforming set\General\G-04.dwg Layout Name: G-04 - Plotted by: Frontlitcher, jim Date: 6/15/2012 - 12:59 PM
 REF: NSD-80 IMAGES: NSD LOGO-transparent_graphics_email.jpg

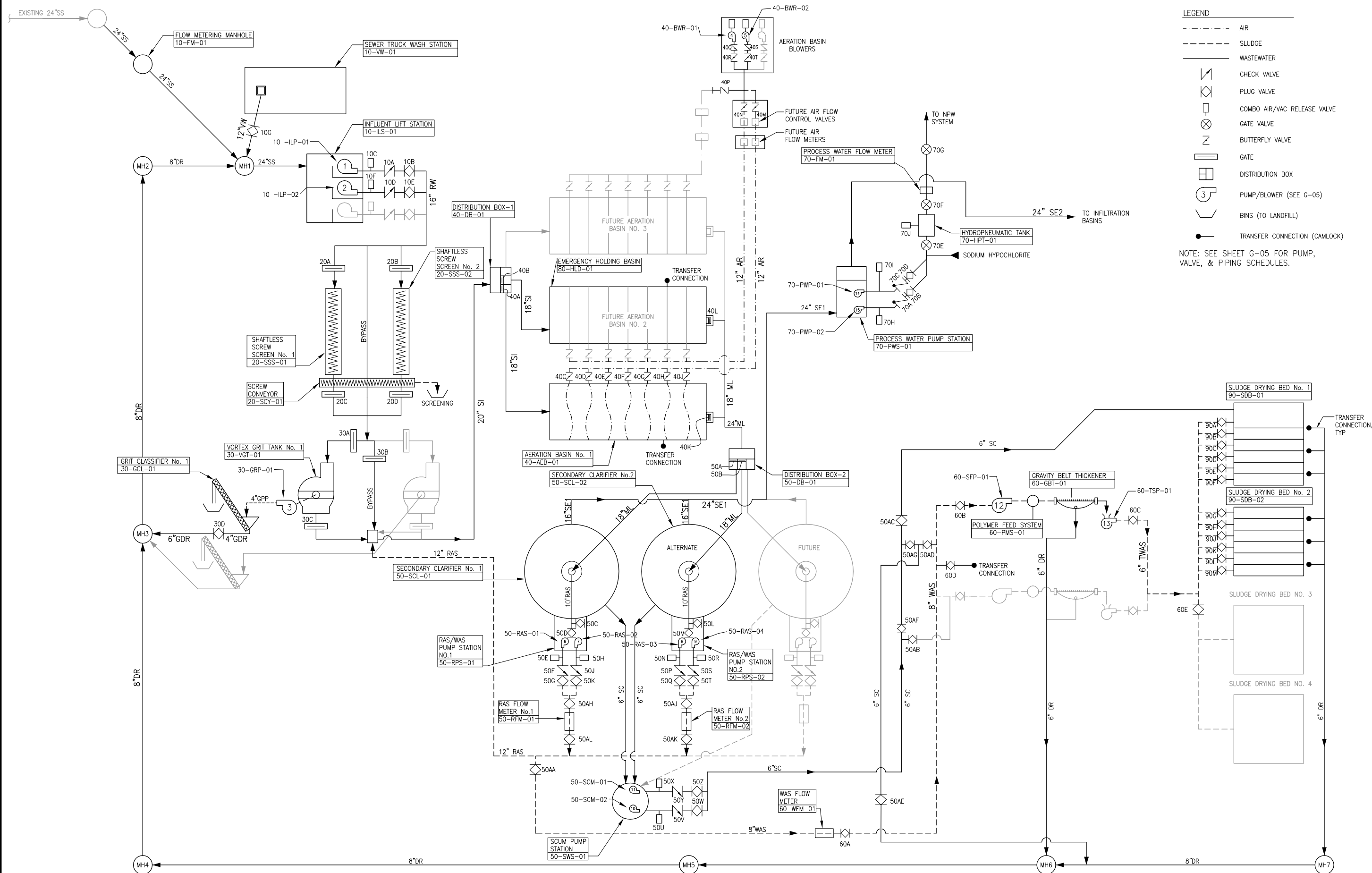

LEGEND

- AIR
- - - - - SLUDGE
- WASTEWATER
- ⌞ CHECK VALVE
- ⊕ PLUG VALVE
- ⊗ COMBO AIR/VAC RELEASE VALVE
- ⊗ GATE VALVE
- ⌞ BUTTERFLY VALVE
- ▭ GATE
- ▭ DISTRIBUTION BOX
- ⊕ PUMP/BLOWER (SEE G-05)
- ⌞ BINS (TO LANDFILL)
- TRANSFER CONNECTION (CAMLOCK)

NOTE: SEE SHEET G-05 FOR PUMP, VALVE, & PIPING SCHEDULES.

NIPOMO COMMUNITY SERVICES DISTRICT SOUTHLAND WWTF IMPROVEMENTS PROCESS FLOW DIAGRAM	NIPOMO <small>COMMUNITY SERVICES DISTRICT</small>
DESIGNED: EKS DETAIL: JPF CHECKED: APPROVED: DATE: FEBRUARY 2012 AECOM PROJECT NO. 60183842 NSD PROJECT NO.	APPR DATE: 12/31/2013 DESCRIPTION: C74757 PROJECT ENGINEER: EILEEN SHIELDS
CADD STDS. AECOM G-04 SHEET 4 OF 181	AECOM Technical Services, Inc. 1194 Pacific Street, Suite 204 San Jose, CA 95128 T 408.542.8940 F 408.542.8990 www.aecom.com

0 1/2 1
 IF THIS BAR DOES NOT
 MEASURE 1" THEN DRAWING IS
 NOT TO FULL SCALE

DWG: P:\nipomo_cad (19996)\southland_wrf_upgrade\000_cadd (2010)\P\meset\conforming set\General\G-06.dwg Layout Name: G-06 - Plotted by: Froelicher, Jim Date: 6/15/2012 - 1:06 PM
 XREFS: NCSD-BD IMAGES: NCSD LOGO-transparent_grypsuite_small.jpg

INFLUENT DESIGN PARAMETERS	
AVERAGE DAILY FLOW (ADF)	0.84 MGD
PEAK HOURLY FLOW (PHF)	2.43 MGD
5-DAY BIOCHEMICAL OXYGEN DEMAND (BOD ₅), 90 th %	300 mg/L
5-DAY BIOCHEMICAL OXYGEN DEMAND (BOD ₅), AVE	250 mg/L
TOTAL SUSPENDED SOLIDS (TSS), 90 th %	300 mg/L
TOTAL SUSPENDED SOLIDS (TSS), AVERAGE	250 mg/L
TOTAL NITROGEN (TN), 90 th %	60 mg/L
TOTAL NITROGEN (TN), AVERAGE	35 mg/L
EFFLUENT DESIGN PARAMETERS	
5-DAY BIOCHEMICAL OXYGEN DEMAND (BOD ₅)	20 mg/L
TOTAL SUSPENDED SOLIDS (TSS)	20 mg/L
TOTAL NITROGEN (TN)	10 mg/L

INFLUENT LIFT STATION (SYSTEM 10)	
NUMBER OF PUMPS	2
PUMP TAGS	10-LP-01 & 10-LP-02
TYPE	SCREW CENTRIFUGAL
CAPACITY (EACH)	1,700 GPM @ 30 FT
MOTOR HP	20 HP

HEADWORKS SCREENS (SYSTEM 20)	
NUMBER OF SCREENS	2
SCREEN TAGS	20-SSS-01 & 20-SSS-02
TYPE	SHAFTLESS SCREW
PEAK CAPACITY (EACH)	4.83 MGD
HEADLOSS (INCHES)	12"
MOTOR HP	1.5

HEADWORKS GRIT TANKS (SYSTEM 30)	
NUMBER OF GRIT TANKS	1
GRIT TANK TAGS	30-GRT-01
TYPE	VORTEX
PEAK CAPACITY	2.5 MGD
GRIT PUMPS	1
GRIT PUMP TAG	30-GRP-01
TYPE	SELF-PRIMING
CAPACITY	250 GPM @ 13 FT TDH
MOTOR HP	2.0 HP
GRIT CLASSIFIER	1
GRIT CLASSIFIER TAG	30-GCL-01
MOTOR HP	1.5 HP

AERATION BASINS (SYSTEM 40)	
NUMBER OF BASINS	1
BASIN TAGS	40-AEB-01
SIZE (WxL) (AT GRADE)	170 FT x 156 FT
DEPTH (AT WATER SURFACE)	11.8 FT
VOLUME	1.41 MG
MIXED LIQUOR SUSPENDED SOLIDS (MLSS)	3,223 mg/L
SOLID RETENTION TIME (SRT)	60-70 DAYS
HYDRAULIC RETENTION TIME (HRT)	1.63 DAY
BLOWERS	
NUMBER OF BLOWERS	2
BLOWER TAGS	40-BWR-01 & 02
TYPE	POSITIVE DISPLACEMENT
CAPACITY (EACH)	1954 ICFM/1738 ICFM
AERATION CHAINS	
NUMBER OF CHAINS	7
DIFFUSER ASSEMBLIES	98
DIFFUSERS	392

SECONDARY CLARIFIERS (SYSTEM 50)	
NUMBER OF CLARIFIERS	2*
TYPE	CIRCULAR
CLARIFIER TAGS	50-SCL-01 & 50-SCL-02*
DIAMETER	55 FT
SIDE WATER DEPTH	15 FT
OVERFLOW RATE (ONE CLARIFIER ONLINE)	
@ ADF	240 gpd/FT ²
@ PHF	694 gpd/FT ²
CENTER DRIVE HP (MIN)	0.5
SLUDGE COLLECTION MECHANISM	SPIRAL SCRAPER
RAS PUMPS	
NUMBER (PER CLARIFIER)	2
TYPE	SUBMERSIBLE
CAPACITY (EACH)	875 GPM
MOTOR HP	10 HP
PUMP TAGS	50-RAS-01 & 50-RAS-02 50-RAS-03* & 50-RAS-04*

*CLARIFIER 50-SCL-02, 50-RAS-03, AND 50-RAS-04 ARE PART OF BID ALTERNATE X

SLUDGE THICKENING SYSTEM (SYSTEM 60)	
WAS FEED PUMP	
NUMBER	1
TYPE	PROGRESSIVE CAVITY
CAPACITY	0 to 120 GPM
MOTOR HP	10 HP
PUMP TAG	60-SFP-01
POLYMER SYSTEM	
METERING PUMP	
NUMBER	1
TYPE	PROGRESSIVE CAVITY
CAPACITY	3.0 GPH
POLYMER TYPE	LIQUID
TAG	60-FMS-01
GRAVITY BELT THICKENER	
NUMBER	1
CAPACITY	50 to 100 GPM
WIDTH	0.5 METER
FEED CONCENTRATION	0.5 to 1.0% TSS
THICKENED SLUDGE CONCENTRATION	4 to 8% TSS
DRIVE MOTOR	1 HP
HYDRAULIC POWER	3 HP
WASHWATER PUMP	
MOTOR	5 HP
CAPACITY	0 to 40 GPM
TAG	60-GBT-01
THICKENED SLUDGE PUMP	
NUMBER	1
CAPACITY	0 to 40 GPM
MOTOR HP	10 HP
PUMP TAG	60-TSP-01

NONPOTABLE WATER PUMP STATION (SYSTEM 70)	
NUMBER OF PUMPS	2
PUMP TAGS	70-PWP-01 & 70-PWP-02
TYPE	VERTICAL TURBINE
CAPACITY	200 GPM @ 60 PSI
MOTOR HP	10
HYDROPNEUMATIC TANK	
TAG	70-HPT-01
SIZE	5,000 GAL
PRESSURE SETTINGS	
MIN	40
MAX	60

EMERGENCY HOLDING BASIN (SYSTEM 80)	
NUMBER OF BASINS	1
BASIN TAG	80-HLD-01
SIZE	150 FT x 180 FT
DEPTH (AT MAX. WATER SURFACE)	11 FT
VOLUME	1.17 MGAL

SLUDGE DRYING BEDS (SYSTEM 90)	
NUMBER OF SLUDGE DRYING BEDS	2
TAGS	90-SDB-01 & 02
NUMBER OF CELLS PER BED	6
AREA PER CELL	5,200 FT ²
TOTAL AREA	62,640 FT ²
MAXIMUM DEPTH	15"

INFILTRATION BASINS*	
NUMBER	2
TOTAL SURFACE AREA	7.76 AC
TOTAL DEPTH	8 FT
MAX WATER DEPTH	6 FT

*INFILTRATION BASINS ARE BID ALTERNATE Y

NOTE:
 1. SYSTEM 45 INCLUDES BLOWER AND ELECTRICAL BUILDING.

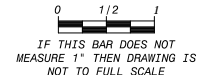

	<p>APPR. DATE: 12/31/2013 DESCRIPTION: SOUTHLAND WWT IMPROVEMENTS REG. NUMBER: C74757 PROJECT ENGINEER: ELLEEN SHIELDS</p>
<p>AECOM Technical Services, Inc. 1194 Pacific Street, Suite 204 San Luis Obispo, California 93401 T 805.542.2940 F 805.542.2990 www.aecom.com</p>	
<p>NIPOMO COMMUNITY SERVICES DISTRICT SOUTHLAND WWT IMPROVEMENTS</p>	
<p>DESIGN PARAMETERS</p>	
DESIGNED: EKS DETAIL: JPF CHECKED: APPROVED: DATE: FEBRUARY 2012 AECOM PROJECT NO.: 60183842 NCSD PROJECT NO.: CADD STDS: AECOM	
<p>G-06 SHEET 6 OF 181</p>	

APPENDIX C

Nipomo Community Services District
Dana Reserve Water and Wastewater Evaluation
Recommended: New 16-Inch Main on North Oak Glen Drive and Tefft Street
OPINION OF PROBABLE PROJECT COST - PLANNING

Item	Description	Quantity	Unit	Unit Price	Amount
1	Mobilization/Demobilization	1	LS	\$313,000	\$313,000
2	Stormwater Pollution Prevention Plan	1	LS	\$60,000	\$60,000
3	Environmental mitigation measures and permits	1	LS	\$40,000	\$40,000
4	Traffic Control	14,900	LF	\$10	\$149,000
5	Furnish and install 16-inch diameter AWWA DIP pipe and appurtenances within paved streets	15,200	LF	\$320	\$4,864,000
6	Furnish and install 30-inch diameter steel casing pipe via trenchless installation with 16-inch diameter AWWA DIP pipe	300	LF	\$1,800	\$540,000
7	Pipe connections to existing system (valves and tee)	13	EA	\$24,000	\$312,000
8	Install service lateral and connect to existing water meters	38	EA	\$4,000	\$152,000
9	Install air release valve	9	EA	\$5,000	\$45,000
10	Install hydrant lateral and connect to existing hydrant	10	EA	\$9,000	\$90,000
Subtotal					\$6,565,000
Administration, Engineering, and Construction Management				30%	\$1,970,000
Construction Contingency				30%	\$1,970,000
Estimated Total Project Cost (Rounded)					\$10,510,000

Notes:

1. Pipeline installation costs include pavement removal/ restoration and pipeline disinfection.
2. Service replacement based on number of parcels along frontage of pipeline alignment. Final estimate to be determined during design.
3. Number of hydrant laterals to be reconnected based on District GIS

Nipomo Community Services District
 Dana Reserve Water and Wastewater Evaluation
 Willow Road End of Line Connection
 OPINION OF PROBABLE PROJECT COST - PLANNING

Item	Description	Quantity	Unit	Unit Price	Amount
1	Mobilization/Demobilization	1	LS	\$8,000	\$8,000
2	Traffic Control	500	LF	\$10	\$5,000
3	Furnish and install 12-inch diameter AWWA C900 PVC pipe and appurtenances within paved streets	500	LF	\$250	\$125,000
4	Pipe connections to existing system (valves and tee)	2	EA	\$12,000	\$24,000
Subtotal					\$162,000
Administration, Engineering, and Construction Management				30%	\$49,000
Construction Contingency				30%	\$49,000
Estimated Total Project Cost					\$260,000
Notes:					
1. Pipeline installation costs include pavement removal/ restoration and pipeline disinfection.					

Nipomo Community Services District
Dana Reserve Water and Wastewater Evaluation
New 1.0 MG Reservoir at Foothill Tank Site
OPINION OF PROBABLE PROJECT COST - PLANNING

Item	Description	Quantity	Unit	Unit Price	Amount
1	Mobilization (5%)	1	LS	\$117,000	\$117,000
2	Earthwork	1	LS	\$100,000	\$100,000
3	Demolition and Site Preparation	1	LS	\$30,000	\$30,000
4	New 1.0 MG Welded Steel Reservoir	1000000	Gal	\$1.25	\$1,250,000
5	Tank Foundation and Anchorage	1	LS	\$250,000	\$250,000
6	Disinfection Booster Facility	1	LS	\$200,000	\$200,000
7	Piping and Valves	1	LS	\$300,000	\$300,000
8	Electrical (Allowance)	1	LS	\$100,000	\$100,000
9	Instrumentation and Controls (Allowance)	1	LS	\$100,000	\$100,000
Subtotal					\$2,447,000
Administration, Engineering, and Construction Management				30%	\$735,000
Construction Contingency				30%	\$735,000
Estimated Total Project Cost (Rounded)					\$3,920,000

Nipomo Community Services District
 Dana Reserve Water and Wastewater Evaluation
New 0.5 MG Reservoir at Joshua Road Pumping Station
 OPINION OF PROBABLE PROJECT COST - PLANNING

Item	Description	Quantity	Unit	Unit Price	Amount
1	2016 Cost Estimate	1	LS	\$2,500,000	\$2,500,000
2	ENR Adjustment				\$471,693
	Subtotal				\$2,971,693
	Administration, Engineering, and Construction Management			30%	\$892,000
	Construction Contingency			30%	\$892,000
	Estimated Total Project Cost (Rounded)				\$4,760,000
Notes:					
1. Construction cost opinion was escalated from Jan 2016 estimate to September 2021 using the ENR-CCI LA cost index (Jan 2016 = 11,115.28 to Sep 2021 = 13,212.48).					

Nipomo Community Services District
Dana Reserve Water and Wastewater Evaluation
Alternative: New 16-Inch Main from Foothill Tanks to Sandydale
OPINION OF PROBABLE PROJECT COST - PLANNING

Item	Description	Quantity	Unit	Unit Price	Amount
1	Mobilization/Demobilization	1	LS	\$254,000	\$254,000
2	Stormwater Pollution Prevention Plan	1	LS	\$60,000	\$60,000
3	Environmental mitigation measures and permits	1	LS	\$40,000	\$40,000
4	Traffic Control	13,200	LF	\$10	\$132,000
5	Furnish and install 16-inch diameter AWWA DIP pipe and appurtenances within paved streets	13,500	LF	\$320	\$4,320,000
6	Furnish and install 30-inch diameter steel casing pipe via trenchless installation with 16-inch diameter AWWA DIP pipe	300	LF	\$1,800	\$540,000
7	Pipe connections to existing system (valves and tee)	2	EA	\$24,000	\$48,000
8	Install air release valve	5	EA	\$5,000	\$25,000
Subtotal					\$5,419,000
Administration, Engineering, and Construction Management				30%	\$1,626,000
Construction Contingency				30%	\$1,626,000
Estimated Total Project Cost (Rounded)					\$8,680,000
Notes:					
1. Pipeline installation costs include pavement removal/ restoration and pipeline disinfection.					

Nipomo Community Services District
Dana Reserve Water and Wastewater Evaluation
Offsite Wastewater Collection System Improvements
OPINION OF PROBABLE CONSTRUCTION COST - PLANNING

Item	Description	Quantity	Unit	Unit Price	ENR Adjustment	Amount (Rounded)
1	Mobilization/Demobilization	1	LS	\$93,920	1.09	\$103,000
2	Stormwater Pollution Prevention Plan	1	LS	\$60,000	1.09	\$66,000
3	Environmental mitigation measures and permits	1	LS	\$40,000	1.09	\$44,000
Upgrade Frontage Road 15-in Gravity Sewer Main						
4	15-in Gravity Sewer	3500	LF	\$250	1.09	\$955,000
5	Precast Manholes w/Coating	12	EA	\$20,000	1.09	\$262,000
6	Laterals	5	EA	\$3,000	1.09	\$17,000
7	Traffic Control/Regulation	3500	LF	\$12	1.09	\$46,000
8	Pavement Repair (Full Lane Width)	1	LS	\$147,000	1.09	\$161,000
9	Abandon Existing Sewerline & Manholes	3500	LF	\$10	1.09	\$39,000
Upgrade Frontage Road 18-in Gravity Sewer Main						
10	18-in Gravity Sewer	1200	LF	\$280	1.09	\$367,000
11	Precast Manholes w/Coating	4	EA	\$20,000	1.09	\$88,000
12	Laterals	10	EA	\$3,000	1.09	\$33,000
13	Traffic Control/Regulation	1200	LF	\$12	1.09	\$16,000
14	Pavement Repair (Full Lane Width)	1	LS	\$52,000	1.09	\$57,000
15	Abandon Existing Sewerline & Appurtenances	1200	LF	\$10	1.09	\$14,000
Subtotal						\$2,268,000
Administration, Engineering, and Construction Management				30%		\$681,000
Construction Contingency				30%		\$681,000
Estimated Total Project Cost (rounded)						\$3,630,000

Notes:

- Lateral replacement based on number of parcels along frontage of pipeline alignment. Final estimate to be determined during design.
- Construction cost opinion was escalated from July 2019 Blacklake Consolidation Study Engineering Report (MKN) to September 2021 using the ENR-CCI LA cost index (June 2019 = 12113.16 to Sep 2021 = 13212.48).

Nipomo Community Services District
Dana Reserve Water and Wastewater Evaluation
Wastewater Treatment Plant Improvements
Basis for Unit Process Costs (Planning-Level)

OPINION OF PROBABLE CAPITAL COST

Item	Description	Unit	Unit Price	Quantity	ENR Adjustment*	Amount
GRIT REMOVAL SYSTEM						
1	Grit Removal Equipment	EA	\$162,000	1	1.28	\$207,800
2	Civil	LS	\$73,000	1	1.28	\$93,600
3	Structural	LS	\$97,000	1	1.28	\$124,400
4	Electrical	LS	\$9,000	1	1.28	\$11,500
5	Instrumentation	LS	\$4,000	1	1.28	\$5,100
<i>Subtotal</i>						\$442,400

BIOLAC WAVE OXIDATION SYSTEM - BASIN						
1	BioLac Equipment	EA	\$628,000	1	1.28	\$805,600
2	Civil	LS	\$86,000	1	1.28	\$110,300
3	Structural	LS	\$179,000	1	1.28	\$229,600
4	Electrical	LS	\$18,000	1	1.28	\$23,100
5	Instrumentation	LS	\$3,000	1	1.28	\$3,800
<i>Subtotal</i>						\$1,172,400

BIOLAC WAVE OXIDATION SYSTEM - BASIN 3						
1	BioLac Equipment	EA	\$628,000	1	1.28	\$805,600
2	Civil	LS	\$344,000	1	1.28	\$441,300
3	Structural	LS	\$179,000	1	1.28	\$229,600
4	Electrical	LS	\$18,000	1	1.28	\$23,100
5	Instrumentation	LS	\$3,000	1	1.28	\$3,800
<i>Subtotal</i>						\$1,503,400

BLOWER BUILDING						
1	Civil	LS	\$89,000	1	1.28	\$114,200
2	Structural	LS	\$267,000	1	1.28	\$342,500
3	Electrical	LS	\$286,000	1	1.28	\$366,900
4	Instrumentation	LS	\$140,000	1	1.28	\$179,600
<i>Subtotal</i>						\$1,003,200

SECONDARY CLARIFIER						
1	Clarifier Equipment	EA	\$203,000	1	1.28	\$260,400
2	RAS/WAS Pump Equipment	EA	\$33,000	2	1.28	\$84,700
3	RAS/WAS Flow Meter	EA	\$11,000	1	1.28	\$14,100
4	Scum Pump Equipment	EA	\$69,000	1	1.28	\$88,500
5	Civil	LS	\$440,000	1	1.28	\$564,400
6	Structural	LS	\$740,000	1	1.28	\$949,200
7	Electrical	LS	\$39,000	1	1.28	\$50,000
8	Instrumentation	LS	\$25,000	1	1.28	\$32,100
<i>Subtotal</i>						\$2,043,400

SLUDGE THICKENING SYSTEM						
1	Sludge Thickening Equipment	EA	\$255,000	1	1.28	\$327,100
2	Flow Meter	LS	\$9,000	1	1.28	\$11,500
3	Civil	LS	\$93,000	1	1.28	\$119,300
4	Structural	LS	\$77,000	1	1.28	\$98,600
5	Electrical	LS	\$28,000	1	1.28	\$35,900
6	Instrumentation	LS	\$16,000	1	1.28	\$20,500
<i>Subtotal</i>						\$612,900

Cost opinions were estimated by averaging bids from the District's 2012 Southland Wastewater Treatment Improvements Project. Construction cost opinion was escalated from May 2012 to September 2021 using the ENR-CCI LA cost index. May 2012 (10300.05) and Sep 2021 (13212.48) values were used to escalate estimated cost to present value.

SLUDGE DEWATERING SCREW PRESS						
1	Screw Press, Building, Structural, Mechanical, Electrical, and Instrumentation	EA	\$1,037,022	1	1.10	\$1,135,900

Cost opinions were estimated by averaging bids from the District's 2020 Southland Wastewater Treatment Facility Dewatering Screw Press Project. Construction cost opinion was escalated from September 2020 to September 2021 using the ENR-CCI LA cost index. September 2020 (12062.34) and Sep 2021 (13212.48) values were used to escalate estimated cost to present value.

Nipomo Community Services District
Dana Reserve Water and Wastewater Evaluation
Wastewater Treatment Plant Improvements Under Future Permit Requirements
OPINION OF PROBABLE CONSTRUCTION COST - PLANNING

Planning Level Project Cost - Southland WWTF Improvements to Meet Existing Demands with Dana Reserve					
Item	Description	Quantity	Unit	Unit Price	Amount (Rounded)
1	Mobilization (5% of Items 2 through 9)	1	LS	\$474,700	\$475,000
2	General Site Grading and Paving (4% of Items 4 through 9)	1	LS	\$293,172	\$294,000
3	General Site Civil (10% of Items 4 through 9)	1	LS	\$732,930	\$733,000
4	Influent Lift Station Pump Improvements	1	LS	\$50,000	\$50,000
5	New Grit Chamber System	1	LS	\$442,400	\$443,000
6	New Aeration Basin #2 and #3	1	LS	\$2,675,800	\$2,676,000
7	New Blower Building and Blower System Improvements	1	LS	\$1,504,800	\$1,505,000
8	New Clarifier and RAS Pumping Improvements	1	LS	\$2,043,400	\$2,044,000
9	New Sludge Thickening System	1	LS	\$612,900	\$613,000
10	New Screw Press	1	LS	\$1,135,900	\$1,136,000
	Subtotal				\$9,969,000
	Construction Contingency			30%	\$2,991,000
	Engineering, Administrative, and Construction Management Allowance			30%	\$2,991,000
				Total	\$15,960,000

ENR (LA) September 2021 = 13212.48